

# Kensington®

## ClickSafe® Keyed Laptop Lock for Non-Standard Security Slots

INSTRUCTION GUIDE  
GUIDE D'INSTRUCTIONS  
BEDIENUNGSANLEITUNG  
HANDLEIDING  
MANUALE DI ISTRUZIONI  
MANUAL DE INSTRUCCIONES

HASZNÁLATI ÚTMUTATÓ  
PŘÍRUČKA S POKYNY  
INSTRUKCJA OBSŁUGI  
РУКОВОДСТВО ПОЛЬЗОВАТЕЛЯ  
MANUAL DE INSTRUÇÕES

دليل التعليمات

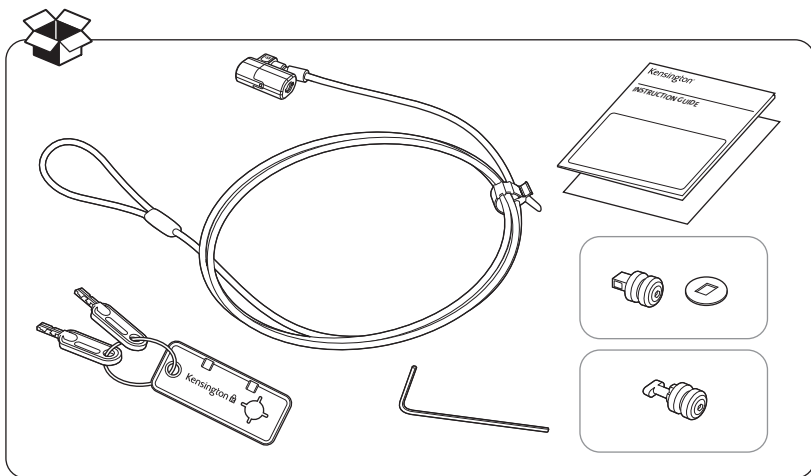

Register Now!  
Enregistrer maintenant !  
Jetzt registrieren!  
Nu registreren  
Registrar ahora  
Registra adesso

Regisztráljon most!  
Zaregistrujte se nyní!  
Zarejestruj się!  
Зарегистрироваться!  
Registe-se agora!  
سجل الآن!

[register.kensington.com](http://register.kensington.com)



IMPORTANT! REGISTER YOUR KEY CODE! /  
IMPORTANT! ENREGISTREZ VOTRE CODE CLÉ! /  
WICHTIG! REGISTRIEREN SIE IHREN KEYCODE! /  
BELANGRIJK! REGISTREER UW SLEUTELCODE! /  
IMPORTANTE! EFFETTUARE LA REGISTRAZIONE DEL  
CODICE DELLA CHIAVE /  
IMPORTANTE: REGISTRE EL CÓDIGO DE LA LLAVE /  
FONTOS! REGISZTRÁLJA A KULCSKÓDJÁT! /  
DŮLEŽITÉ! REGISTRUJTE KÓD SVÉHO KLÍČE! /  
WAŻNE! ZAREJESTRUJ KOD KLUCZYKA! /  
ВАЖНО! ЗАРЕГИСТРИРУЙТЕ СВОЙ КОД КЛЮЧА! /  
IMPORTANTE! FAÇA O REGISTO DO SEU CÓDIGO CHAVE! /  
مهم! تسجيل رمز المفتاح الخاص بك!

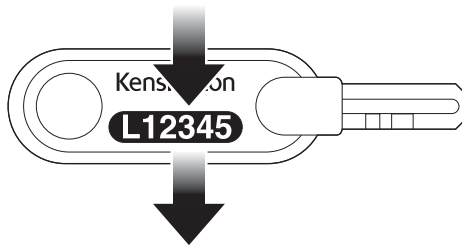

**register.kensington.com**

#

--	--	--	--	--	--

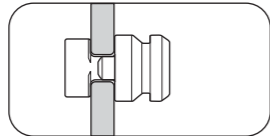
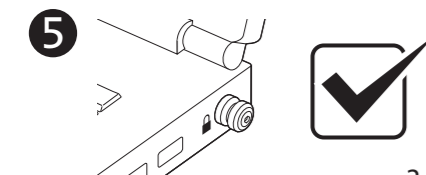
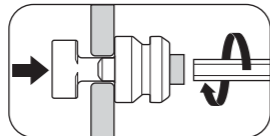
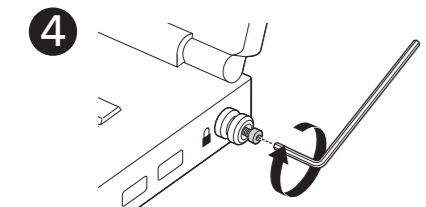
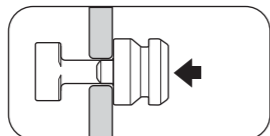
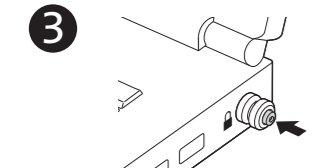
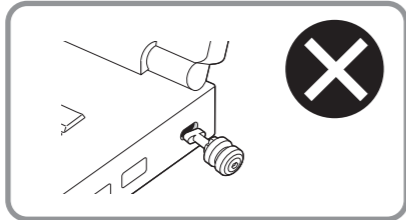
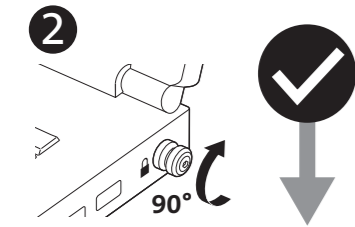
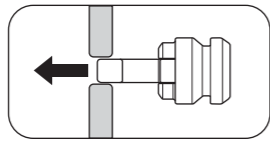
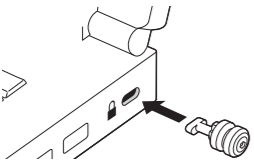
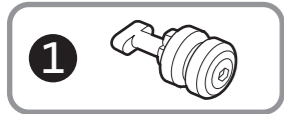

2

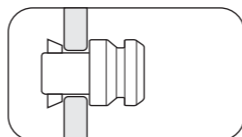
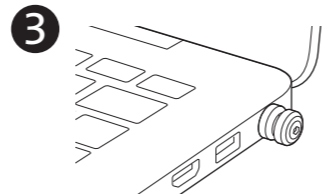
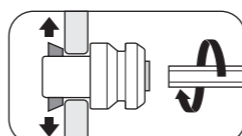
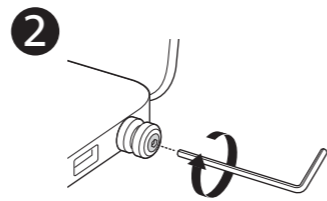
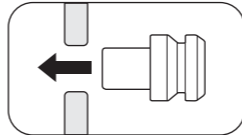
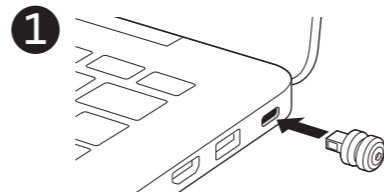
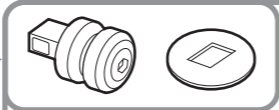

3

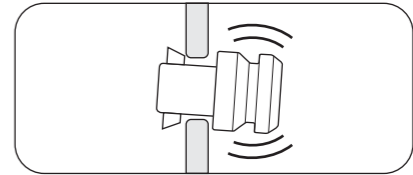

⋮

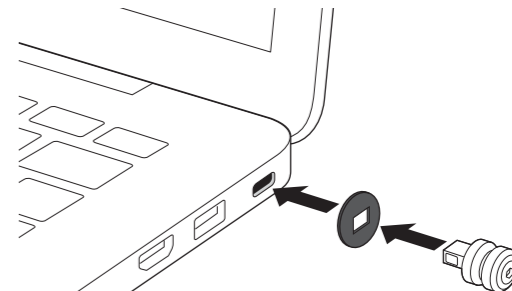

⋮

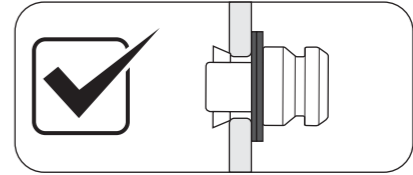

4

1

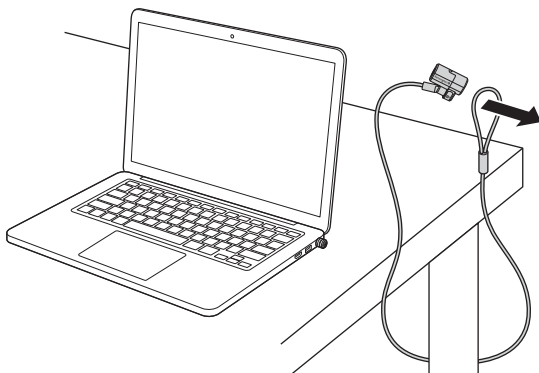

2

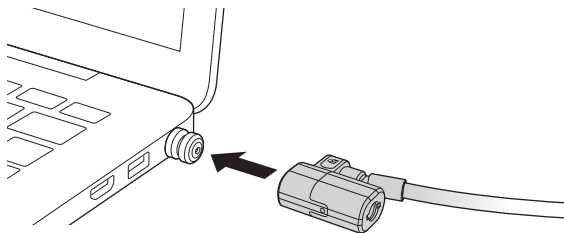

3

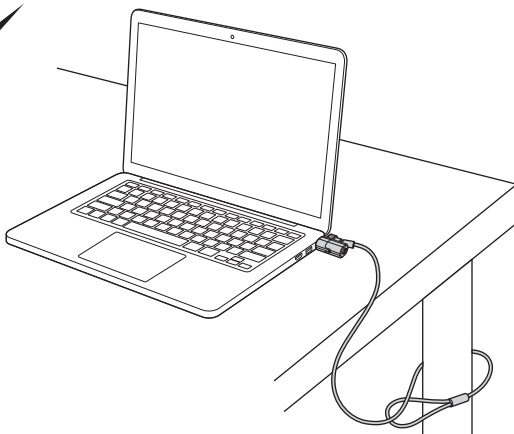

1

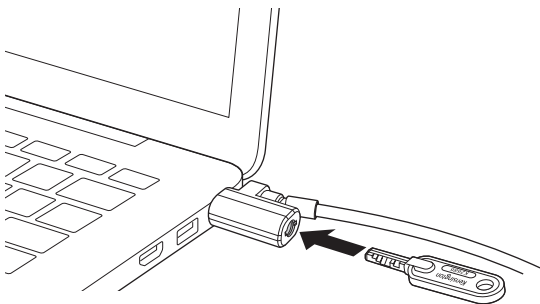

2

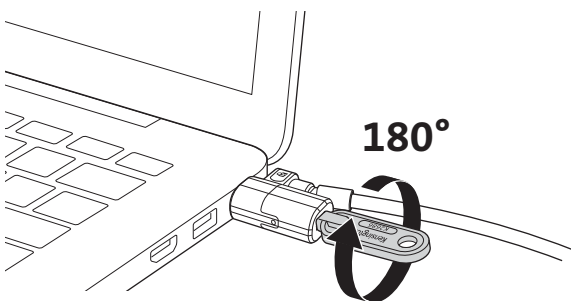

3

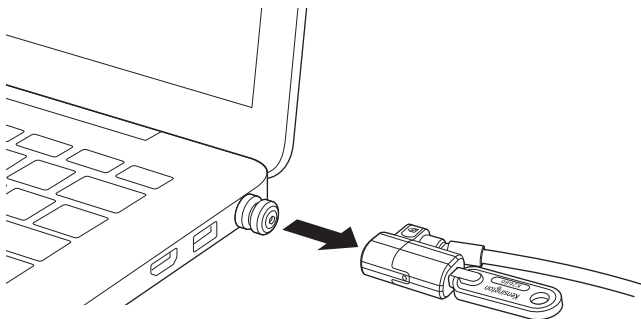

Kensington and the ACCO name and design are registered trademarks of ACCO Brands. ClickSafe is a registered trademark of ACCO Brands. All other registered and unregistered trademarks are the property of their respective owners.

©2016 Kensington Computer Products Group, a division of ACCO Brands. Any unauthorized copying, duplicating, or other reproduction of the contents hereof is prohibited without written consent from Kensington Computer Products Group. All rights reserved. 07/16



**Kensington Computer Products Group**  
A Division of ACCO Brands  
1500 Fashion Island Blvd, 3rd Floor  
San Mateo, CA 94404



**ACCO Brands Europe**

A Division of ACCO Brands Europe  
Oxford House, Oxford Road  
Aylesbury, Buckinghamshire,  
HP21 8SZ  
United Kingdom

**Importado por ACCO Mexicana  
S.A. de C.V.**

Circuito de la Industria Norte # 6,  
Corredor Industrial Toluca Lerma,  
Lerma México Cp. 52004  
R.F.C. AME640229-1W3

**ACCO Brands Canada Inc**

7381 Bramalea Rd  
Mississauga,  
ON L5S 1C4  
Canada

**Acco Brands Chile S.A.,**

Avda. San Josemaría  
Escrivá de Balaguer N°5773  
Vitacura, C.P. 7640970  
Santiago, Chile

**ACCO Australia**

Level 2, 8 Lord St  
Botany NSW 2019  
Australia

**Importado e Distribuido por:**

TILIBRA PRODUTOS DE PAPELARIA LTDA.  
CNPJ: 44.990.901/0001-43  
Rua Aymorés, 6-9 – Bauru/SP – Brasil  
CEP 17013-900

[www.kensington.com](http://www.kensington.com)