

# Galaxy 5000/Galaxy 5500

40–130 kVA 480 V,  
20–120 kVA 400 V

## Operation

04/2016



# Legal Information

The Schneider Electric brand and any registered trademarks of Schneider Electric Industries SAS referred to in this guide are the sole property of Schneider Electric SA and its subsidiaries. They may not be used for any purpose without the owner's permission, given in writing. This guide and its content are protected, within the meaning of the French intellectual property code (Code de la propriété intellectuelle français, referred to hereafter as "the Code"), under the laws of copyright covering texts, drawings and models, as well as by trademark law. You agree not to reproduce, other than for your own personal, noncommercial use as defined in the Code, all or part of this guide on any medium whatsoever without Schneider Electric's permission, given in writing. You also agree not to establish any hypertext links to this guide or its content. Schneider Electric does not grant any right or license for the personal and noncommercial use of the guide or its content, except for a non-exclusive license to consult it on an "as is" basis, at your own risk. All other rights are reserved.

Electrical equipment should be installed, operated, serviced, and maintained only by qualified personnel. No responsibility is assumed by Schneider Electric for any consequences arising out of the use of this material.

As standards, specifications, and designs change from time to time, please ask for confirmation of the information given in this publication.

# Table of Contents

Important Safety Instructions — SAVE THESE	
INSTRUCTIONS .....	5
FCC Statement .....	6
Safety Precautions .....	6
User Interface .....	7
Overview of the Mimic Diagram .....	8
Menu Tree .....	9
UPS Configuration .....	10
View Measurements .....	10
View Alarms .....	10
View Status .....	10
Configure Settings .....	11
Configure the Personalization Functions .....	11
Configure Controls .....	13
Configure the Synchronization Module (Option) .....	13
Controls Settings .....	13
Source Type Settings .....	13
Operation .....	14
Operating Modes .....	14
Normal (Double Conversion) Mode .....	14
ECO Mode (Single UPS Only) .....	14
Frequency Converter Mode .....	14
Load on Battery Power .....	14
Synchronization Module Modes (Option) .....	15
Operation Procedures .....	16
UPS Breakers and Switches .....	16
Start Up a Single UPS on Input Source .....	17
Start Up a Single UPS on Bypass Source .....	18
Shut Down a Single UPS .....	19
Restart a Single UPS .....	20
Shut Down a Parallel Configuration .....	21
Restart a Galaxy 5000 480 V Parallel Configuration .....	22
Restart a Galaxy 5500 400 V Parallel Configuration .....	23
Isolate the UPS .....	24
Return the UPS to Normal Operation .....	31
Operation of the Dry Contact Communication Card .....	37
Standard Mode .....	37
Programmable Mode .....	38
List of Operating Status Conditions for Dry Contact Output	
Relays .....	38
Maintenance .....	41
Life Cycle Monitoring (LCM) .....	41
Servicing Batteries .....	42
Troubleshooting .....	43
Identify the Alarms .....	43
Synchronisation Module Alarms (Option) .....	44
Alarm or Status Display Messages .....	44



# Important Safety Instructions — SAVE THESE INSTRUCTIONS

Read these instructions carefully and look at the equipment to become familiar with it before trying to install, operate, service or maintain it. The following safety messages may appear throughout this manual or on the equipment to warn of potential hazards or to call attention to information that clarifies or simplifies a procedure.



The addition of this symbol to a “Danger” or “Warning” safety message indicates that an electrical hazard exists which will result in personal injury if the instructions are not followed.



This is the safety alert symbol. It is used to alert you to potential personal injury hazards. Obey all safety messages with this symbol to avoid possible injury or death.

## **DANGER**

**DANGER** indicates a hazardous situation which, if not avoided, **will result in death or serious injury**.

**Failure to follow these instructions will result in death or serious injury.**

## **WARNING**

**WARNING** indicates a hazardous situation which, if not avoided, **could result in death or serious injury**.

**Failure to follow these instructions can result in death, serious injury, or equipment damage.**

## **CAUTION**

**CAUTION** indicates a hazardous situation which, if not avoided, **could result in minor or moderate injury**.

**Failure to follow these instructions can result in injury or equipment damage.**

## **NOTICE**

**NOTICE** is used to address practices not related to physical injury. The safety alert symbol shall not be used with this type of safety message.

**Failure to follow these instructions can result in equipment damage.**

## Please Note

Electrical equipment should only be installed, operated, serviced, and maintained by qualified personnel. No responsibility is assumed by Schneider Electric for any consequences arising out of the use of this material.

A qualified person is one who has skills and knowledge related to the construction, installation, and operation of electrical equipment and has received safety training to recognize and avoid the hazards involved.

## FCC Statement

### NOTICE

#### RISK OF INTERFERENCE

This equipment has been tested and found to comply with the limits for a Class A digital device, pursuant to Part 15 of the FCC Rules. These limits are designed to provide reasonable protection against harmful interference when the equipment is operated in a commercial environment. This equipment generates, uses, and can radiate radio frequency energy and, if not installed and used in accordance with the instruction manual, may cause harmful interference to radio communications. Operation of this equipment in a residential area is likely to cause harmful interference in which case the user will be required to correct the interference at his own expense.

**Failure to follow these instructions can result in equipment damage.**

## Safety Precautions

### ⚠ DANGER

#### HAZARD OF ELECTRICAL SHOCK, EXPLOSION OR ARC FLASH

All safety instructions in this document must be read, understood and followed.

**Failure to follow these instructions will result in death or serious injury.**

### ⚠ DANGER

#### HAZARD OF ELECTRICAL SHOCK, EXPLOSION OR ARC FLASH

After the UPS system has been electrically wired, do not start up the system. Start-up must only be performed by Schneider Electric.

**Failure to follow these instructions will result in death or serious injury.**

## User Interface

### Overview of the Display, the ON/OFF Buttons, and the Function Keys

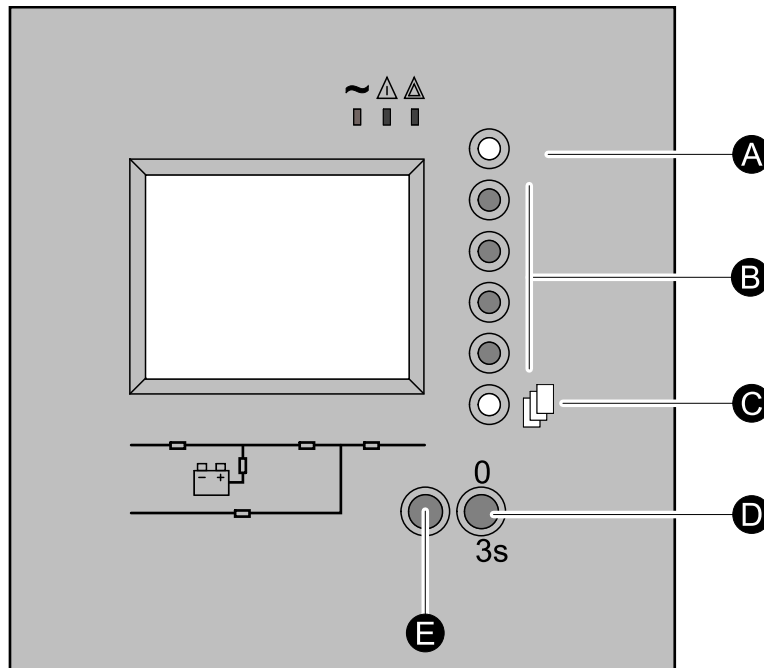

- A. Help key
- B. Function keys. Each key corresponds to a function presented on the display.
- C. Menu key. Provides direct access to the main menu.
- D. Inverter OFF button
- E. Inverter ON button

**NOTE:** The display indicates the UPS operating status conditions and any alarms and events related to the input source or the UPS as well as necessary corrective action.

### Overview of the Status LEDs

The status LEDs placed above the display shows the current status of the UPS system:

#### The Load LED

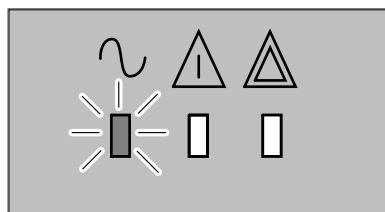

The load LED is ON: The load is supplied and protected by the UPS.

**The Warning Alarm LED**

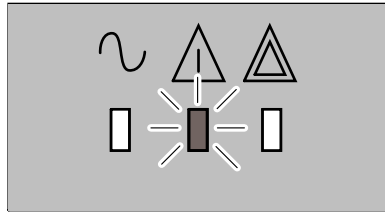

The warning alarm LED is ON: The load is supplied, but not protected by the UPS.

**The Critical Alarm LED**

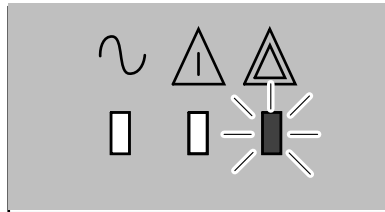

The critical alarm LED is ON: The load is not protected. The load is either not supplied or will reach the end of battery runtime very soon.

**Overview of the Mimic Diagram**

The mimic diagram shows the power flow through the UPS system, and the status of the main functions. Each LED can be in one of the below three states:

- Green: The corresponding function is active and OK.
- Red: The corresponding function is not functioning properly.
- Off: The corresponding function is not active.

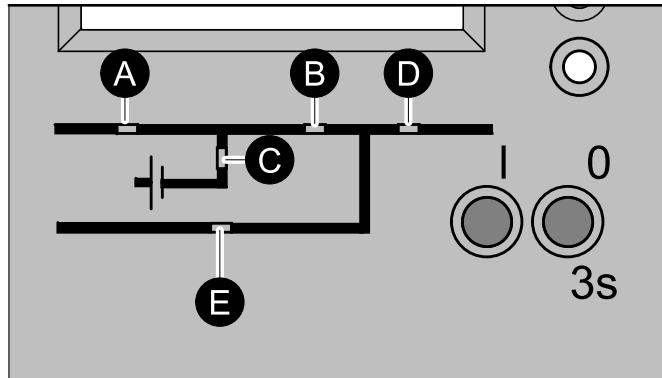

- A. Input/PFC LED
- B. Inverter LED
- C. Battery LED
- D. Load LED
- E. Bypass LED



## Menu Tree

### Measurements

Battery measurements

Voltage measurements

Current measurements

Power measurements

Frequency measurements

Ratio measurements

Parallel measurements (optional)

### Alarms

### Status

Time-stamped events

Statistics

### Settings

Language

Date and time

Contrast

Buzzer volume

Personalization

Output voltage

Password

Relay contacts

### Controls

Reset alarms

Inverter on

Inverter off

Force load transfer to inverter

Force load transfer to bypass

Desynchronize inverter from bypass

Resynchronize inverter and bypass

Test LEDs

Turn buzzer OFF

Enable LCM indications

Disable LCM indications

# UPS Configuration

## View Measurements

1. Press the Menu key.
2. Use the function keys ↑ or ↓ to highlight **Measurements** on the display and press the function key ← to select.
3. Use the function keys ↑ or ↓ to choose between the following measurements and press the function key ← to select:
  - **Battery Measurements**
  - **Voltage Measurements**
  - **Current Measurements**
  - **Power Measurements**
  - **Frequency Measurements**
  - **Ratio Measurements**
  - **Parallel Measurements** (optional)

## View Alarms

Detailed information on all alarms is supplied on the display. See the *Alarm or Status Display Messages, page 44*.

1. Press the Menu key.
2. Use the function keys ↑ or ↓ to highlight **Alarms** on the display and press the function key ← to select.
3. Use the function keys ↑ or ↓ to choose between the alarm messages and press the function key ← to select.

## View Status

1. Press the Menu key.
2. Use the function keys ↑ or ↓ to highlight **Status** on the display and press the function key ← to select.
3. Use the function keys ↑ or ↓ to choose between the following two status screens and press the function key ← to select.
  - **Time-stamped events**
  - **Statistics**

## Configure Settings

1. Press the Menu key.
2. Use the function keys ↑ or ↓ to highlight **Settings** on the display and press the function key ← to select.
3. Use the function keys ↑ or ↓ to choose between the settings screens and press the function key ← to select:
  - **Language**
  - **Date and time**
  - **Contrast**
  - **Buzzer volume**
  - **Personalization**
  - **Output voltage**
  - **Password**
  - **Relay contacts**

**NOTE:** The default password is set to:



## Configure the Personalization Functions

**NOTE:** To configure personalization functions switches Q1 and Q5N must be in the open (OFF) position and switches Q4S and Q3BP must be in the closed (ON) position.

1. Press the Menu key.
2. Select **Settings > Personalization** by pressing the function keys ↑ or ↓ and confirm by pressing the function key ←.
3. Enter the password by successively selecting each icon using the corresponding function key and confirm by pressing the function key ←.

**NOTE:** The default password is set to:

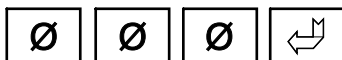

4. Select a personalization function by pressing the function keys ↑ or ↓ and confirm by pressing the function key ←. Use the function keys ↑, ↓, and ← to change the settings. Available personalization functions are:

### Operating Mode

Personalization Function	Default Setting	Available Settings
UPS operating mode	NORMAL	ECO
Automatic start	Disabled	Enabled
No. of auto starts after limiting	4	1 to 255
Auto start delay after limiting	4 seconds	1 to 60 seconds

### Frequency

Personalization Function	Default Setting	Available Settings
Rated output frequency	For 480 V: 60 Hz	60 Hz
	400 V: 50 Hz	
Bypass frequency tolerances	8 %	0.5 – 1 – 2 – 4 %
Inverter sync. rate	2 Hz / s	1 Hz / s

### Automatic Bypass

Personalization Function	Default Setting	Available Settings
Transfer to bypass	Enabled	Disabled – disabled when limiting
Transfer to BP outside tol.	Enabled	Disabled

### Battery

Personalization Function	Default Setting	Available Settings
% low battery warning voltage (if battery monitor inactive)	40 % of remaining backup time	20 – 60 – 80 % of remaining backup time
Low battery warning time (if battery monitor active)	4 minutes of battery backup time	1 to X minutes of battery backup time
Battery test interval	30 days	1 to 180 days

5. To save the settings, confirm by pressing the function key ←.

## Configure Controls

1. Press the Menu key.
2. Use the function keys ↑ or ↓ to highlight **Controls** on the display and press the function key ← to select.
3. Use the function keys ↑ or ↓ to choose between the controls screens and press the function key ← to select:
  - **Reset Alarms**
  - **Inverter on**
  - **Inverter off**
  - **Force load transfer to inverter**
  - **Force load transfer to bypass**
  - **Desynchronize inverter from bypass**
  - **Resynchronize inverter and bypass**
  - **Test LEDs**
  - **Turn buzzer OFF**
  - **Enable LCM indications**
  - **Disable LCM indications**

## Configure the Synchronization Module (Option)

### Controls Settings

Synchronization module controls are located in the synchronization module rear panel.

Mode	Preferred Master	Source Synchronization Mode	Unit State
Automatic-source	Reference source <sup>1</sup>	Auto	Enabled
Fixed-source	Reference source <sup>1</sup>	Fixed	Enabled

### Source Type Settings

Define UPS source type, between utility/mains or standby engine generator set, on COSS board connector XM3:

Source Type	Source 1	Source 2
	Contact Between Pins 7 and 8	Contact Between Pins 9 and 10
Utility/mains	Open	Open
Engine generator set	Closed	Closed

1. If source S1 is selected, source S2 is controlled.

# Operation

## Operating Modes

### Normal (Double Conversion) Mode

When in normal mode, the UPS supports the load with conditioned power from the input source.

The load LED is on.

### ECO Mode (Single UPS Only)

The main advantage of ECO mode is a reduction in the consumption of electrical power. In this mode, under normal conditions, the UPS operates continuously on power from the bypass source. If the bypass mains goes outside tolerance, a transfer to the inverter takes place. The load may experience a short duration interruption of power (3 ms) during this transfer. When the bypass mains comes back within tolerance, the load is again supplied with power from the bypass source.

The load LED is ON.

### Frequency Converter Mode

Frequency converter mode is a configuration without a bypass source connected. When the power is turned on, the UPS starts up and goes automatically online to supply the load with a frequency different from the input. Only the Galaxy 5500 400 V UPS can function as a frequency converter.

### Load on Battery Power

If the utility/mains supply is missing, the UPS transfers to battery operation and supports the load with conditioned power from the DC source.

The warning LED is ON and the buzzer sounds intermittently.

## Synchronization Module Modes (Option)

The synchronization module synchronizes two or more power sources supplying a static transfer switch. Two modes are available:

- **Automatic-source mode:** Both sources can be controlled.
- **Fixed source mode:** Only one source can be controlled.

When the UPS is controlled by the synchronization module, the warning alarm LED is ON and the display shows this message: **UPS on external synchronization.**

On the synchronization module, the following LEDs are ON:

- The **SYNCHRONISED SOURCE** LED is ON. The phase deviation is within tolerances. **Sources are synchronized.**
- The **S2 CONTROLLED SOURCE** LED is ON. Reference source is source S1. **Controlled source is source S2.**
- The **ACTIVATED** LED is ON. **Synchronization function is activated.**

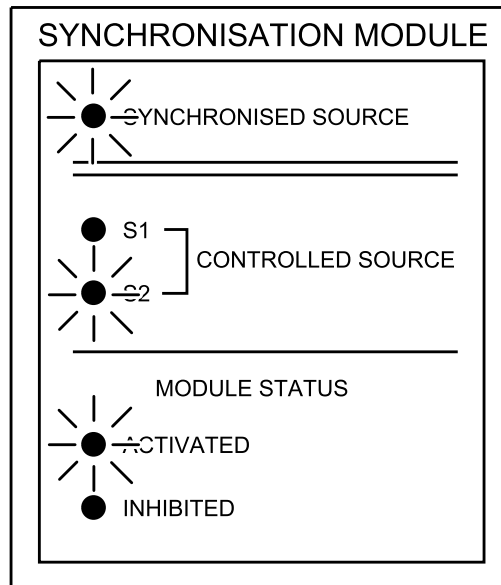

# Operation Procedures

## UPS Breakers and Switches

### 480 V

Breakers and Switches	
<b>Q1</b>	Input switch
<b>Q4S</b>	Bypass switch
<b>Q3BP</b>	Maintenance bypass switch
<b>Q5N</b>	Output switch

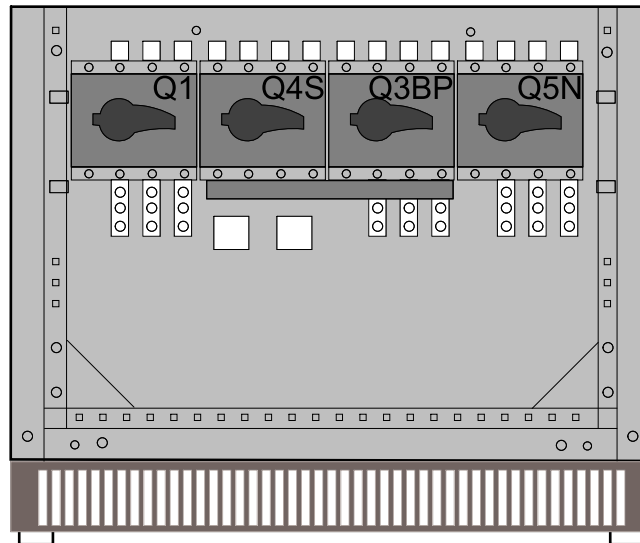

### 400 V

Breakers and Switches	
<b>Q1</b>	Input switch
<b>Q4S</b>	Bypass switch
<b>Q3BP</b>	Maintenance bypass switch
<b>Q5N</b>	Output switch
<b>QF1</b>	Battery circuit breaker

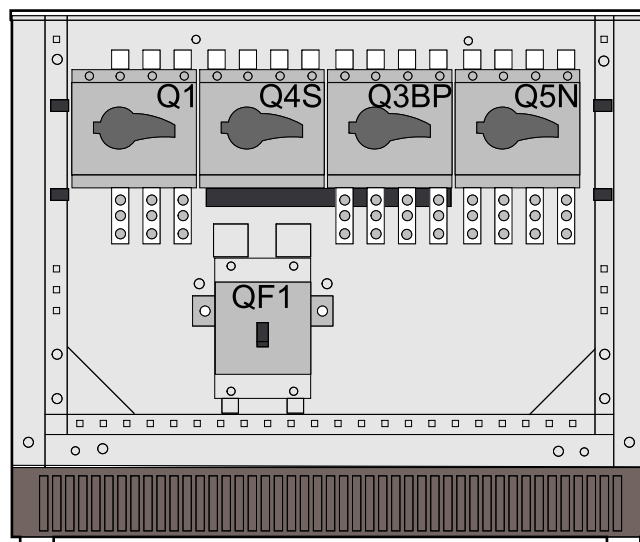



## Start Up a Single UPS on Input Source

1. Set the input switch Q1 to ON.
2. Set the battery circuit breaker:
  - For 480 V: Set the battery circuit breaker of the auxiliary cabinets to ON.
  - For 400 V: Set the battery circuit breaker QF1 (or the battery circuit breakers of the auxiliary cabinets, if any) to ON.
3. Set the bypass switch Q4S to ON.
4. Set the output switch Q5N to ON.
5. Set the maintenance bypass switch Q3BP to OFF.
6. Press the Inverter ON button to start the UPS.

480 V

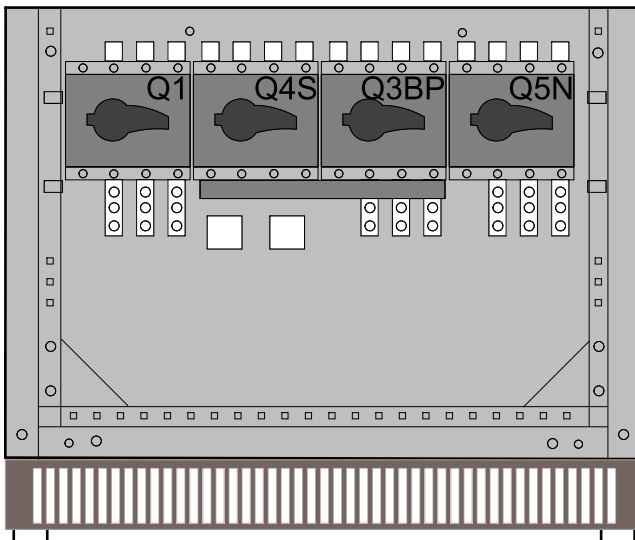

400 V

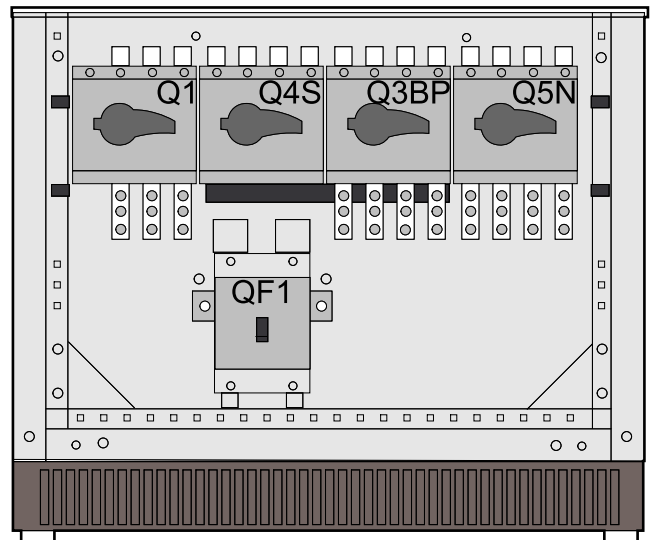

## Start Up a Single UPS on Bypass Source

1. Set the bypass switch Q4S to ON.
2. Set the output switch Q5N to ON.
3. Set the maintenance bypass switch Q3BP to OFF.
4. Set the input switch Q1 to ON.
5. Set the battery circuit breaker:
  - For 480 V: Set the battery circuit breaker of the auxiliary cabinets to ON.
  - For 400 V: Set the battery circuit breaker QF1 (or the battery circuit breakers of the auxiliary cabinets, if any) to ON.
6. Press the Inverter ON button to start the UPS.

480 V

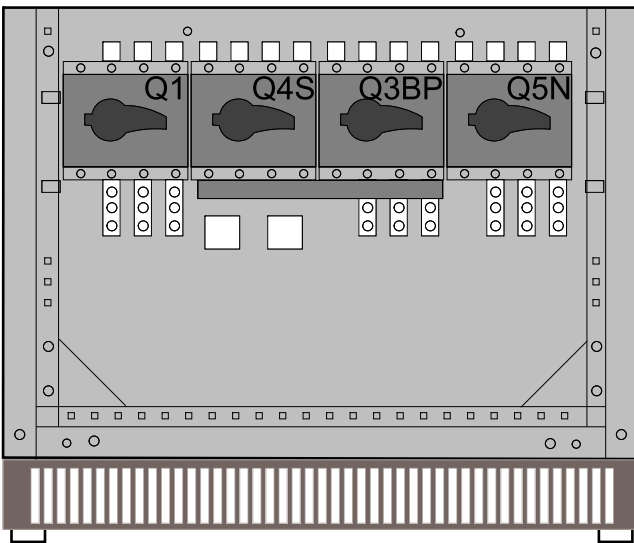

400 V

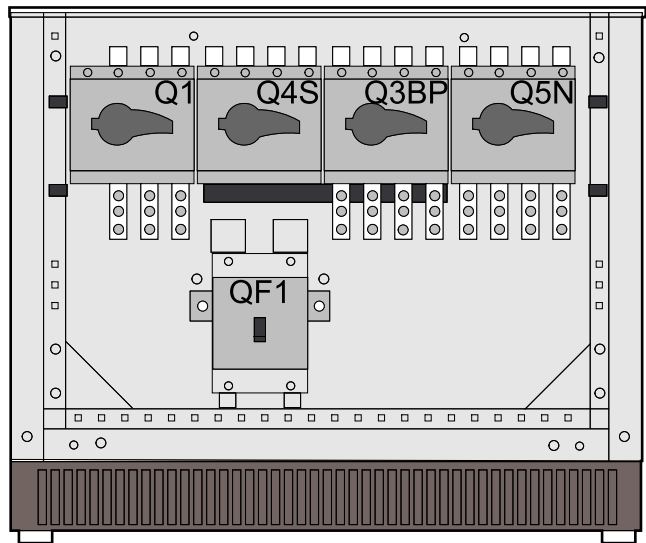

## Shut Down a Single UPS

1. Press a random button on the display to exit sleep mode.
2. Press the Inverter OFF button for 3 seconds. **The load is no longer protected by the UPS. It is supplied via the bypass.**
3. Set the battery circuit breaker:
  - For 480 V: Set the battery circuit breaker of the auxiliary cabinets to OFF.
  - For 400 V: Set the battery circuit breaker QF1 (or the battery circuit breakers of the auxiliary cabinets, if any) to OFF
4. Set the input switch Q1 to OFF. **The charger no longer operates to keep the batteries fully charged.**
5. Open the upstream circuit breakers of the input source and bypass sources to completely power off the UPS.

480 V

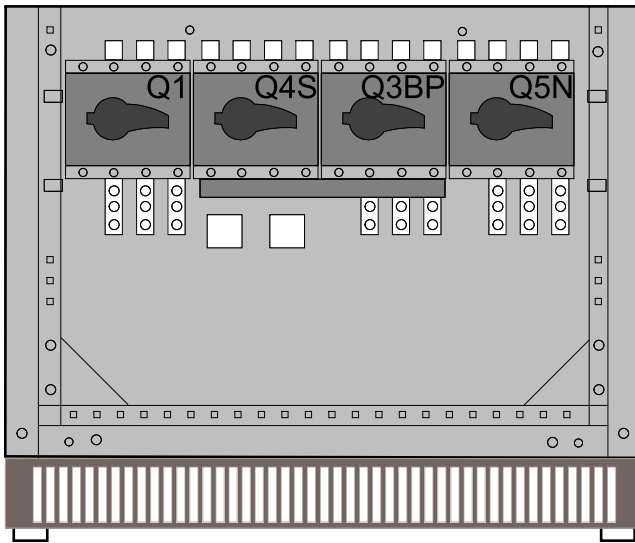

400 V

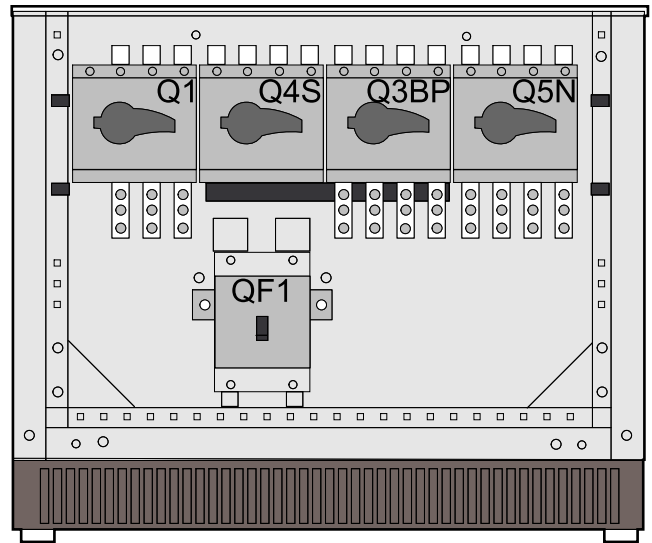

## Restart a Single UPS

Check that switches Q4S and Q5N are closed. If this is the case, continue with this procedure, otherwise refer to *Return Single UPS to Normal Operation*, page 31.

1. Set the input switch Q1 to ON.
2. Wait until the end of the UPS initialization with PFC start-up.
3. Set the battery circuit breaker:
  - For 480 V: Set the battery circuit breaker of the auxiliary cabinets to ON.
  - For 400 V: Set the battery circuit breaker QF1 (or the battery circuit breakers of the auxiliary cabinets, if any) to ON.
4. Press the Inverter ON button to start the UPS.

**The load is protected by the UPS.**

If the load LED remains OFF and if the warning alarm LED or the critical alarm LED is ON, see *Identify the Alarms*, page 43.

480 V

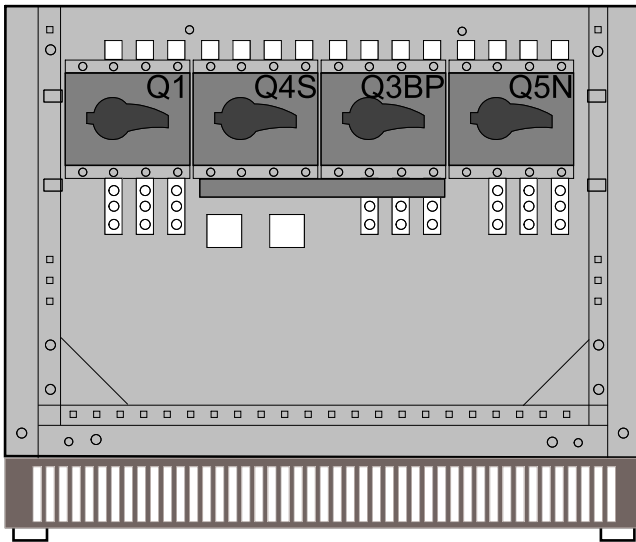

400 V

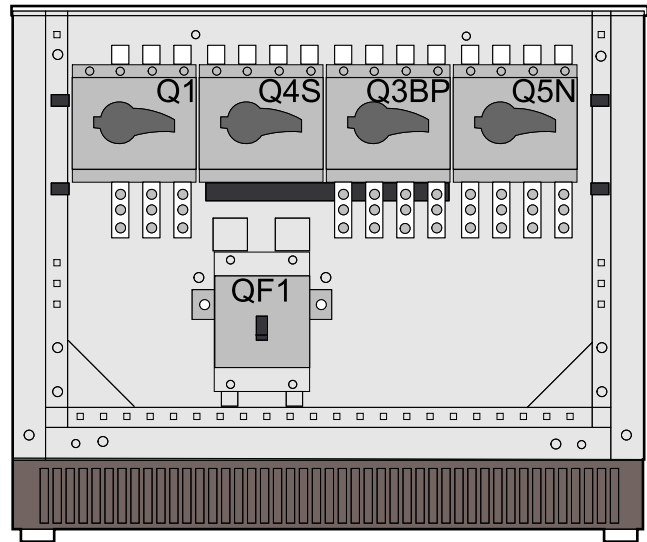

## Shut Down a Parallel Configuration

1. Press a random button on each UPS display to exit sleep mode.
2. Press the Inverter OFF button on each UPS for 3 seconds. **The load is no longer protected by the UPSs. It is supplied via the bypass.**
3. Set the battery circuit breaker:
  - For 480 V: Set the battery circuit breakers of the auxiliary cabinets to OFF.
  - For 400 V: Set the battery circuit breaker QF1 in each UPS (or the battery circuit breakers of the auxiliary cabinets, if any) to OFF.
4. Set the input switch Q1 in each UPS to OFF. **The charger no longer operates to keep the batteries fully charged.**
5. Open the upstream circuit breakers of the input and bypass sources to completely power off the installation.

480 V

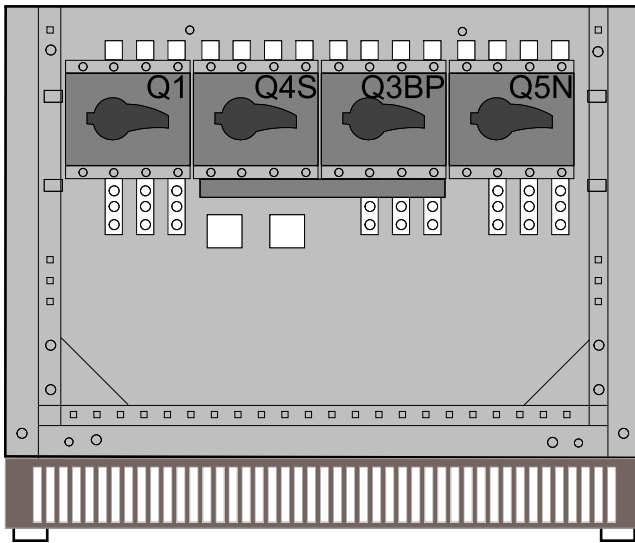

400 V

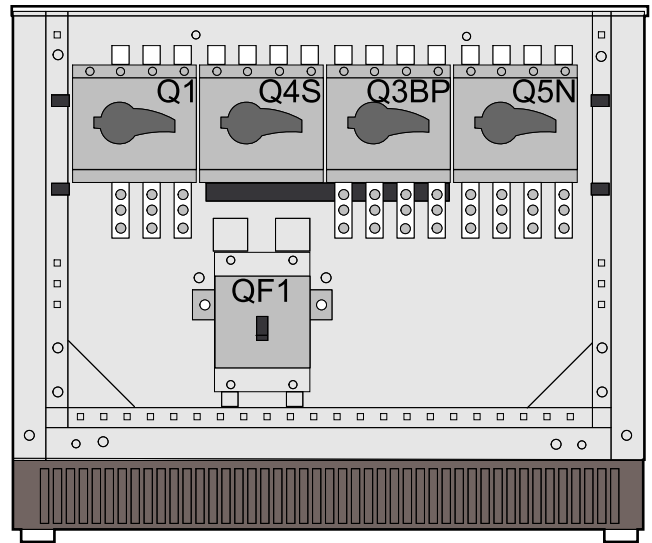

## Restart a Galaxy 5000 480 V Parallel Configuration

Check that switches Q4S and Q5N are closed. If this is the case, continue with this procedure, otherwise see *Return to Normal Operation, Parallel UPS Without External Bypass Cabinet, page 32* or *Return Galaxy 5000 480 V Parallel UPS with External Bypass Cabinet to Normal Operation, page 35*.

1. Check that the output switch CB2 in the external bypass cabinet is closed.
2. Check that the bypass switch CB1 in the external bypass cabinet is open.  
**Carry out steps 3 to 6 below on each of the UPSs.**
3. Set the input switch Q1 to ON.
4. Wait until the end of the start sequence.
5. Set the battery circuit breaker of the auxiliary cabinets to ON.
6. Press the Inverter ON button to start the UPS.

On each UPS, the warning alarm LED and the critical alarm LED turn OFF and the load LED turns ON. **The load is protected by the UPSs.**

If the load LED remains OFF and the warning alarm LED or the critical alarm LED is ON, see *Identify the Alarms, page 43*.

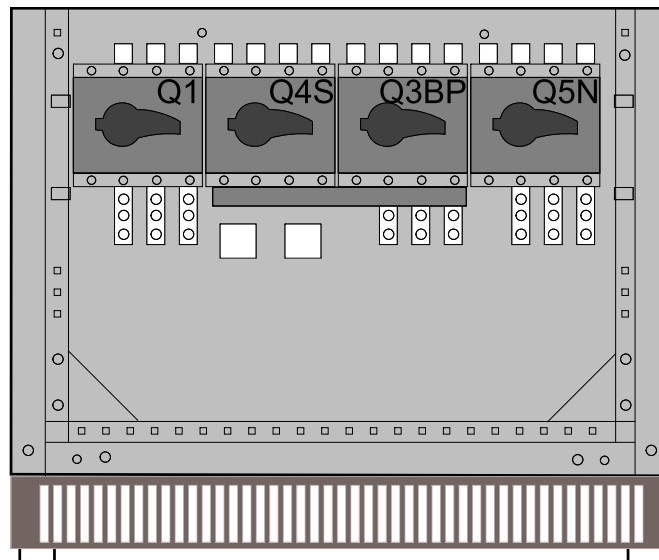

## Restart a Galaxy 5500 400 V Parallel Configuration

Check that switches Q4S and Q5N are closed. If this is the case, continue with this procedure, otherwise refer to *Return to Normal Operation, Parallel UPS Without External Bypass Cabinet*, page 32.

1. Check that the bypass switch Q4S in the external bypass cabinet is closed.
2. Check that the output switch Q5N in the external bypass cabinet is closed.
3. Check that the maintenance bypass switch Q3BP in the external bypass cabinet is open.

**Carry out steps 4 to 7 below on each of the UPSs.**

4. Set the input switch Q1 to ON.
5. Wait until the end of the start sequence.
6. Set the battery circuit breaker QF1 (or the battery circuit breakers of the auxiliary cabinets, if any) to ON.
7. Press the Inverter ON button to start the UPS.

On each UPS, the warning alarm LED and the critical alarm LED turn OFF and the load LED turns ON. **The load is protected by the UPSs.**

If the load LED remains OFF and the warning alarm LED or the critical alarm LED is ON, see *Identify the Alarms*, page 43.

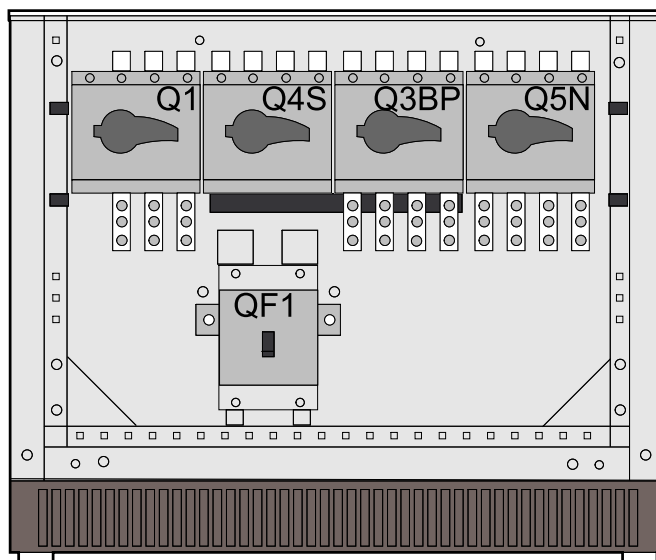

## Isolate the UPS

### Isolate a Single UPS

This procedure isolates the UPS from the electrical power source while the load is supplied directly by the input or bypass source.

## ⚠ DANGER

### HAZARD OF ELECTRIC SHOCK, EXPLOSION, OR ARC FLASH

After this operation, power will still be present on the power connection terminals. Ensure that the protection covers are installed.

**Failure to follow these instructions will result in death or serious injury.**

1. Press a random button on the display to exit sleep mode.
2. Press the Inverter OFF button for 3 seconds to shut down the UPS. **The load is no longer protected by the UPS.**
3. Set the maintenance bypass switch Q3BP to ON.
4. Set the output switch Q5N to OFF.
5. Set the battery circuit breaker:
  - For 480 V: Set the battery circuit breaker of the auxiliary cabinets to OFF.
  - For 400 V: Set the battery circuit breaker QF1 (or the battery circuit breakers of the auxiliary cabinets, if any) to OFF.
6. Set the input switch Q1 to OFF.
7. Set the bypass switch Q4S to OFF.
8. Wait until the display and LEDs turn off.

**The load is no longer protected by the UPS, but continues to be supplied directly from the bypass source. UPS maintenance or servicing can now be carried out.**

480 V

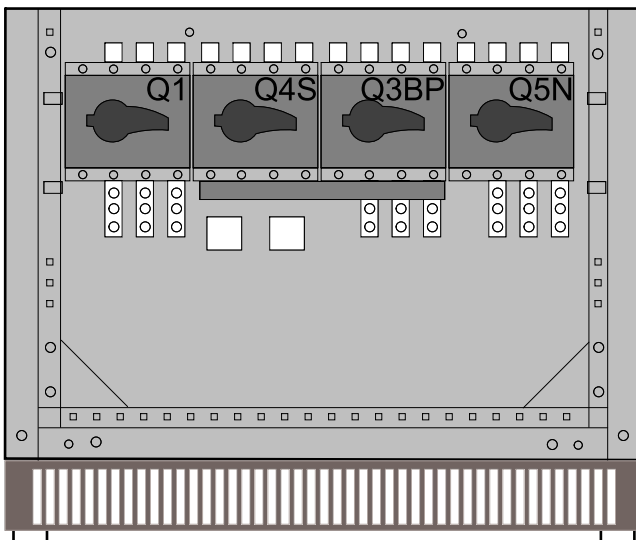

400 V

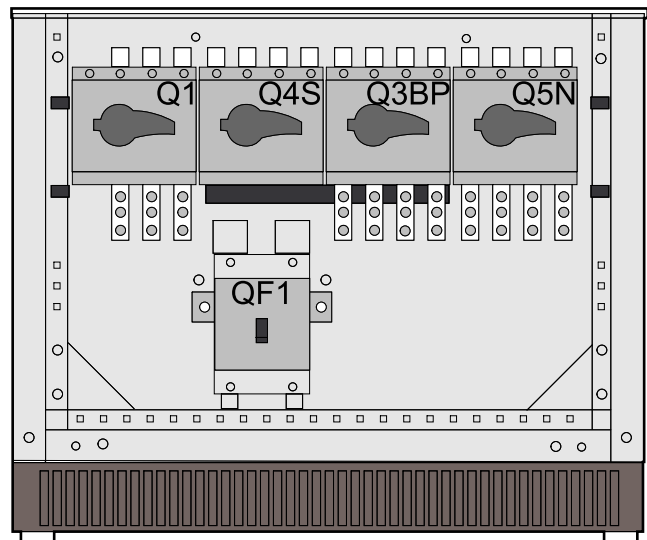

### Isolate a Galaxy 5500 400 V UPS Functioning as Frequency Converter

1. Press a random button on the display to exit sleep mode.



2. Press the Inverter OFF button for 3 seconds to shut down the UPS. **The load is no longer protected by the UPS.**
3. Set the battery circuit breaker QF1 (or the battery circuit breakers of the auxiliary cabinets, if any) to OFF.
4. Set the input switch Q1 to OFF.
5. Open all Q4S and Q5N switches.  
**UPS maintenance can now be carried out.**

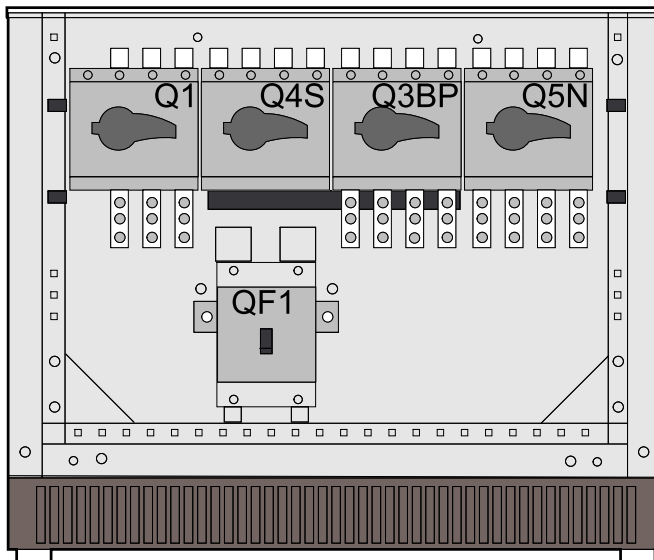

### Isolate a UPS Operating in ECO Mode

**If supplied by the bypass source.**

1. Check in the mimic diagram that the load is supplied by the bypass source. The bypass LED must be on.
2. Set the maintenance bypass switch Q3BP to ON.
3. Set the output switch Q5N to OFF.
4. Set the battery circuit breaker:
  - For 480 V: Set the battery circuit breaker of the auxiliary cabinets to OFF.
  - For 400 V: Set the battery circuit breaker QF1 (or the battery circuit breakers of the auxiliary cabinets, if any) to OFF.
5. Set the input switch Q1 to OFF.

- Set the bypass switch Q4S to OFF.

The load is no longer protected by the UPS, but continues to be supplied directly from the bypass source. UPS maintenance or servicing can now be carried out.

480 V

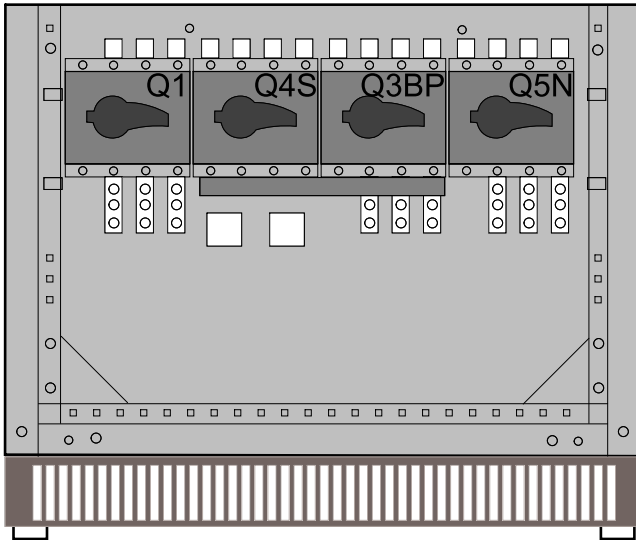

400 V

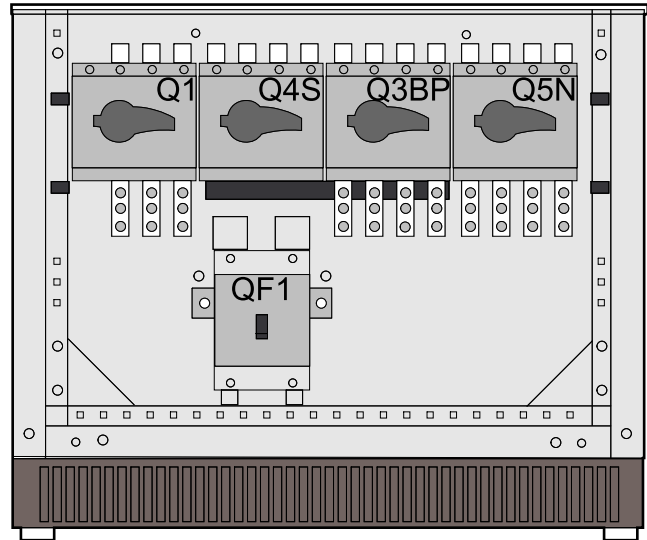

### Isolate a Parallel System Without External Bypass Cabinet

## ⚠ DANGER

### HAZARD OF ELECTRIC SHOCK, EXPLOSION, OR ARC FLASH

After this operation, power will still be present on the power connection terminals. Ensure that the protection covers are installed.

**Failure to follow these instructions will result in death or serious injury.**

- Check that the two UPSs are operating.
- Press a random button on the UPS 1 display to exit sleep mode.
- Press the Inverter OFF button for 3 seconds to shut down UPS 1.
- Set the output switch Q5N to OFF on UPS 1.
- Set the battery circuit breaker:
  - For 480 V: Set the battery circuit breakers of the auxiliary cabinets to OFF.
  - For 400 V: Set the battery circuit breaker QF1 on UPS 1 (or the battery circuit breakers of the auxiliary cabinets, if any) to OFF.
- Set the input switch Q1 to OFF on UPS 1.
- Set the bypass switch Q4S to OFF on UPS 1.

8. Wait until the display and LEDs turn off on UPS 1.

**The load is still protected by the other UPS. Maintenance or servicing can now be carried out on UPS 1.**

480 V

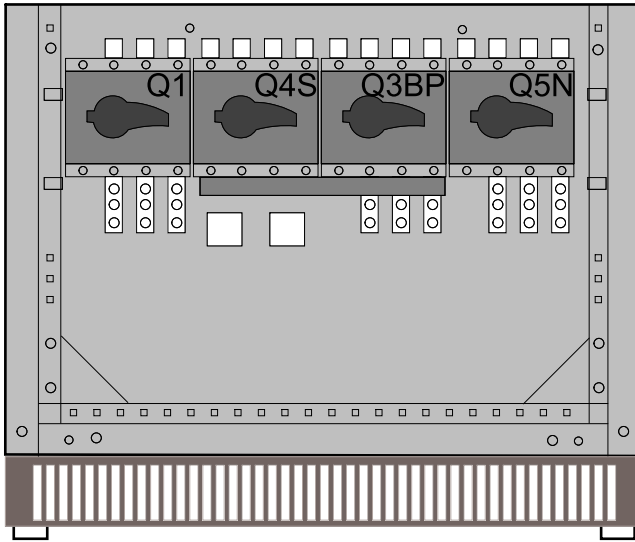

400 V

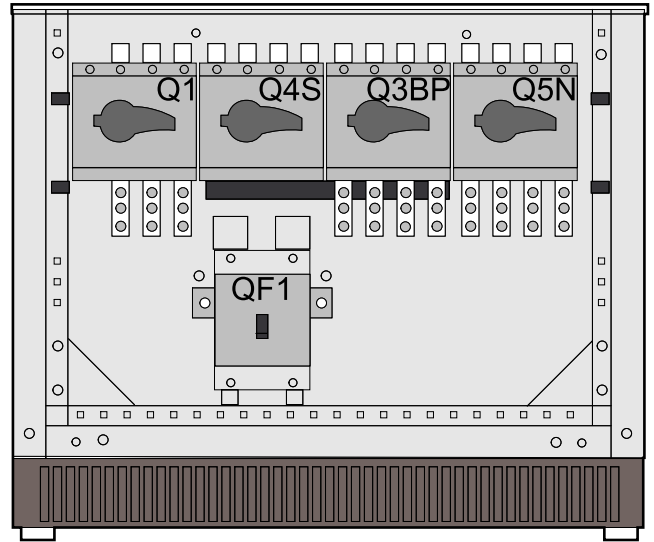

9. Press a random button on the UPS 2 display to exit sleep mode.

10. Press the Inverter OFF button for 3 seconds to shut down UPS 2.

11. Set the maintenance bypass switch Q3BP to ON on UPS 2.

12. Set the output switch Q5N to OFF on UPS 2.

13. Set the battery circuit breaker:

- For 480 V: Set the battery circuit breakers of the auxiliary cabinets to OFF.
- For 400 V: Set the battery circuit breaker QF1 on UPS 2 (or the battery circuit breakers of the auxiliary cabinets, if any) to OFF.

14. Set the input switch Q1 to OFF on UPS 2.

15. Set the bypass switch Q4S to OFF on UPS 2.

16. Wait until the display and LEDs turn off on UPS 2.

**The load is no longer protected by the UPSs, but continues to be supplied directly from the bypass source. Maintenance or servicing can now be carried out on UPS 2.**

480 V

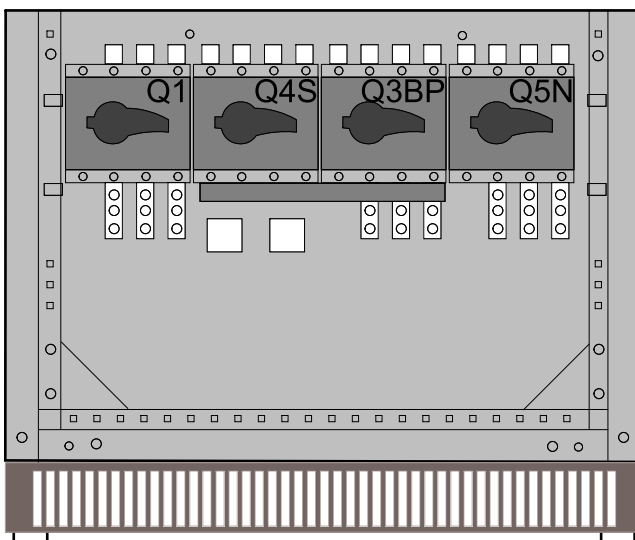

400 V

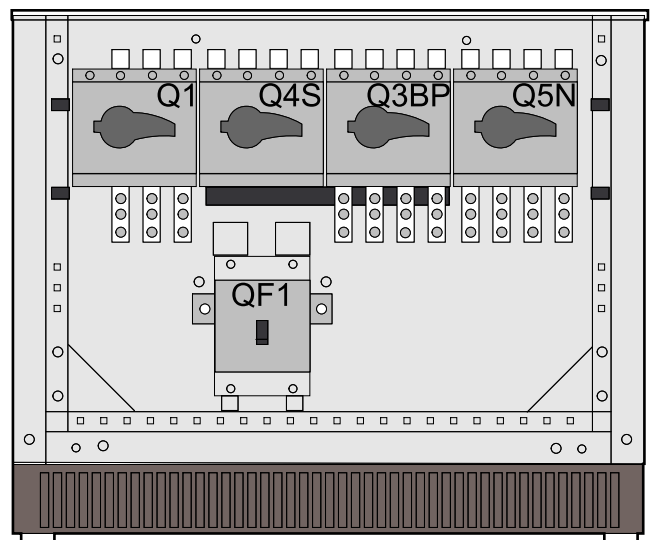

## Isolate Parallel UPS With External Bypass Cabinet

### Shut Down and Isolate One UPS in a Parallel System With External Bypass Cabinet

1. Check that the total capacity of the remaining UPSs is sufficient to supply the connected load.
2. Press a random button on the display on UPS 1 to exit sleep mode.
3. Press the Inverter OFF button for 3 seconds to shut down UPS 1.
4. Set the output switch Q5N to OFF on UPS 1.
5. Set the battery circuit breaker:
  - For 480 V: Set the battery circuit breakers of the auxiliary cabinets to OFF.
  - For 400 V: Set the battery circuit breaker QF1 on UPS 1 (or the battery circuit breakers of the auxiliary cabinets, if any) to OFF.
6. Set the input switch Q1 to OFF on UPS 1.
7. Set the bypass switch Q4S to OFF on UPS 1.
8. Wait until the display and LEDs turn off on UPS 1.

**The load is still protected by the other UPSs. Maintenance or servicing can now be carried out on UPS 1.**

480 V

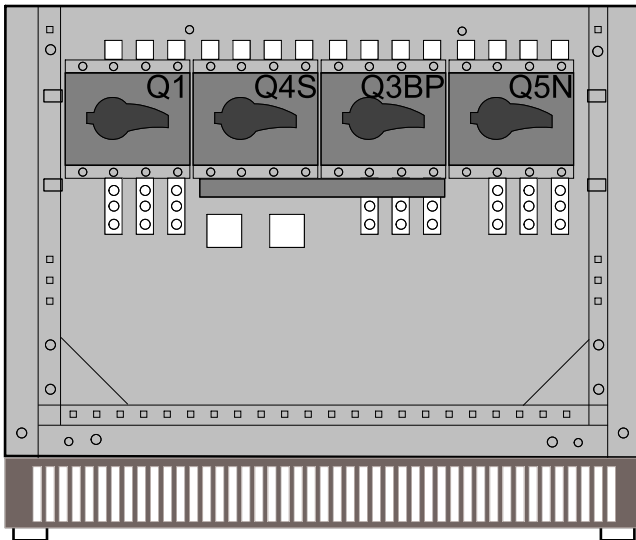

400 V

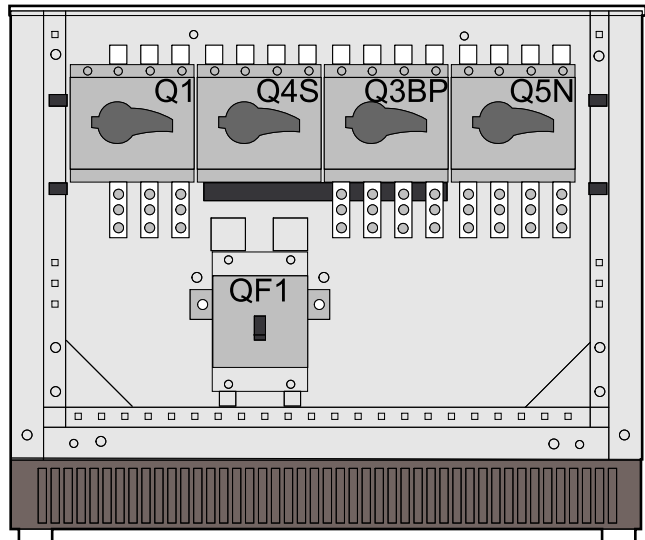

## Shut Down a Parallel System

### Shut Down a Galaxy 5000 480 V Parallel System With External Bypass Cabinet

1. On each UPS, press a random button on the display to exit sleep mode.
2. Press the Inverter OFF button for 3 seconds on each UPS to shut them down.
3. Depress the “transfer initiate” switch on the external bypass cabinet. Unlock “KS” and remove key (G).
4. Insert key (G) into CB1. Unlock and close CB1.
5. Unlock and open CB2 and remove key (H).
6. Insert key (H) into key interlock “KS” and turn to lock.
7. Open output isolation CB11–CB16, as applicable, and open all Q5N switches of each UPS.
8. Open the battery circuit breaker of each UPS.

9. Open Q1 and Q4S switches on each UPS.
10. Turn off all inputs to the UPSs.
11. Wait until the control electronics of all UPSs have fully shut down.

**The load is no longer protected by the UPSs, but continues to be supplied directly from the bypass source. UPS maintenance or servicing can now be carried out.**

**External Bypass Cabinet**

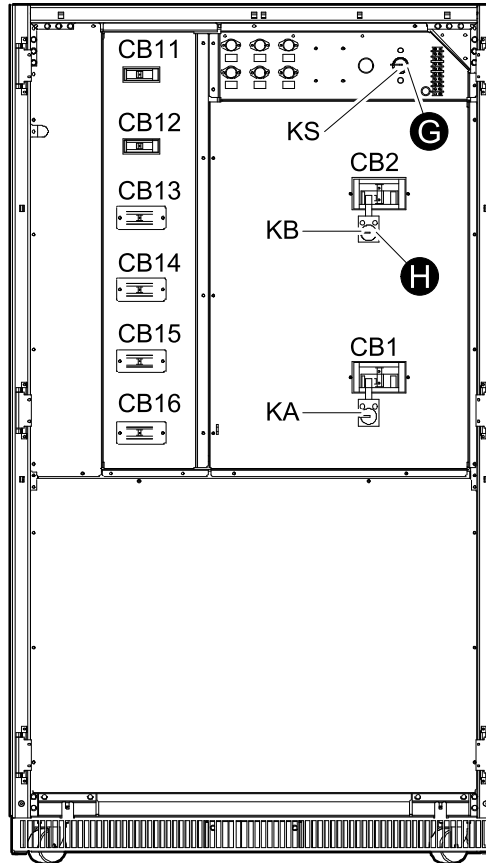

**UPS Cabinet**

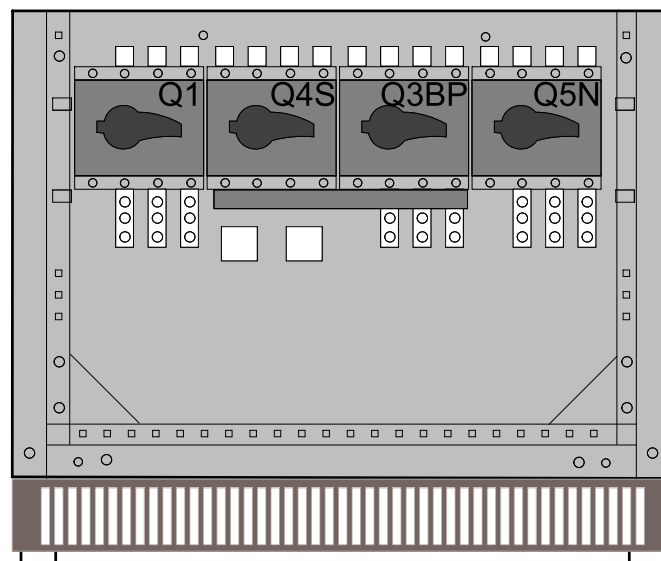

**Shut Down a Galaxy 5500 400 V Parallel System With External Bypass Cabinet**

1. On each UPS, press a random button to exit sleep mode.

2. Press the Inverter OFF button for 3 seconds on each UPS to shut them down.
3. Set the Q3BP switch in the external bypass cabinet to ON.
4. Set the Q5N switch in the external bypass cabinet to OFF.
5. Set the Q4S switch in the external bypass cabinet to OFF.
6. Set the output switch Q5N on each UPS to OFF.
7. Set the battery circuit breaker QF1 (or the battery circuit breakers of the auxiliary cabinets, if any) to OFF.
8. Set the input switch Q1 on each UPS to OFF.
9. Set the bypass switch Q4S on each UPS to OFF.
10. Wait until the control electronics of all UPSs have fully shut down.

**The load is no longer protected by the UPSs, but continues to be supplied directly from the bypass source. UPS maintenance or servicing can now be carried out.**

### External Bypass Cabinet

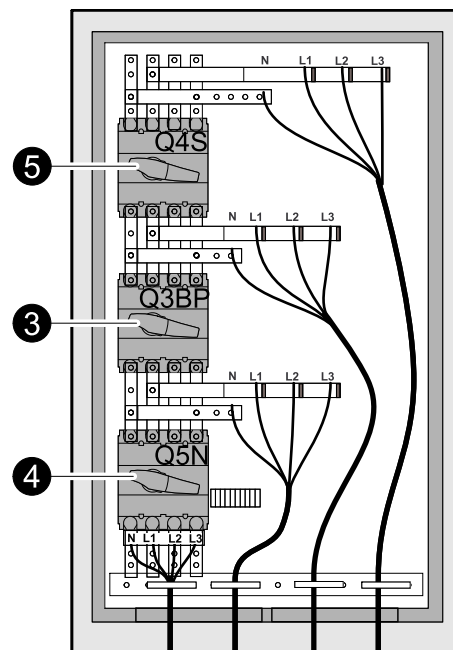

### UPS Cabinet

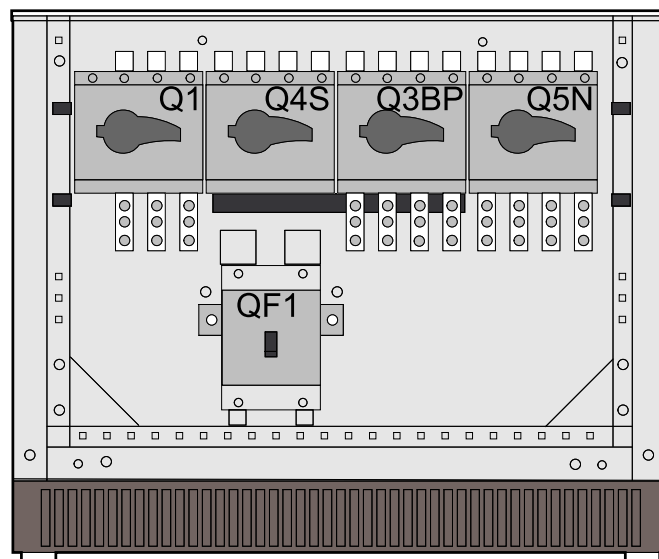

## Return the UPS to Normal Operation

### Return Single UPS to Normal Operation

1. Check that the maintenance bypass switch Q3BP is ON and that all other switches are OFF.
2. Set the bypass switch Q4S to ON.
3. Set the output switch Q5N to ON.
4. Wait until the display turns on and check that there are no alarms on the static switch on the bypass line.
5. Set the maintenance bypass switch Q3BP to OFF.
6. Set the input switch Q1 to ON.
7. Set the battery circuit breaker:
  - For 480 V: Set the battery circuit breakers of the auxiliary cabinets to ON.
  - For 400 V: Set the battery circuit breaker QF1 (or the battery circuit breakers of the auxiliary cabinets, if any) to ON.
8. Press the Inverter ON button to start the UPS.

**The load LED is ON.**

If the load LED remains OFF and the warning alarm LED or the critical alarm LED is ON, see *Identify the Alarms*, page 43.

480 V

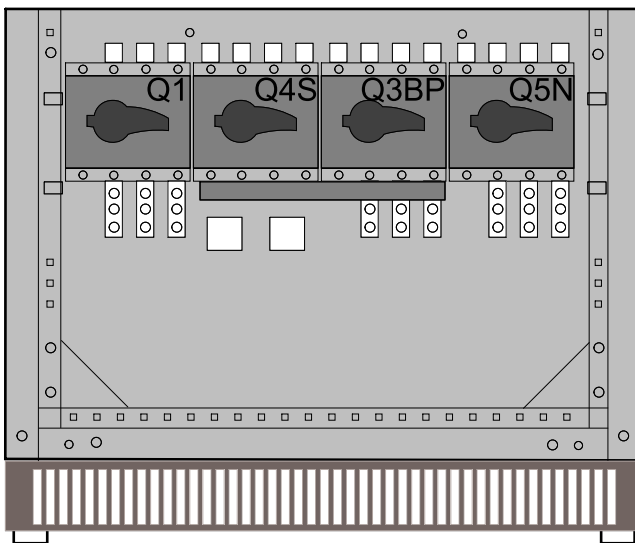

400 V

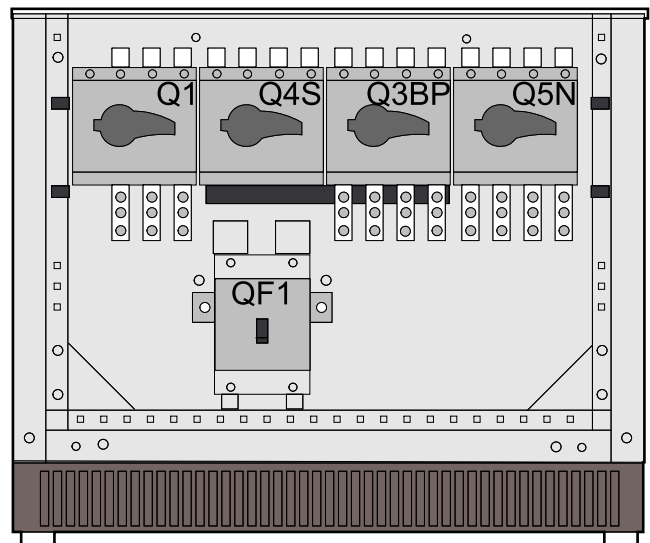

### Return a Galaxy 5500 400 V UPS Functioning as Frequency Converter to Normal Operation

1. Check that all switches are OFF.
2. Set the bypass switch Q4S to ON (check that no cable is connected on phase 1, phase 2 and phase 3).
3. Set the input switch Q1 to ON.
4. Set the output switch Q5N to ON.
5. Set the battery circuit breaker QF1 (or the battery circuit breakers of the auxiliary cabinets, if any) to ON.

- Press the Inverter ON button to start the UPS.

If the load LED remains OFF and the warning alarm LED or the critical alarm LED is ON, see *Identify the Alarms*, page 43.

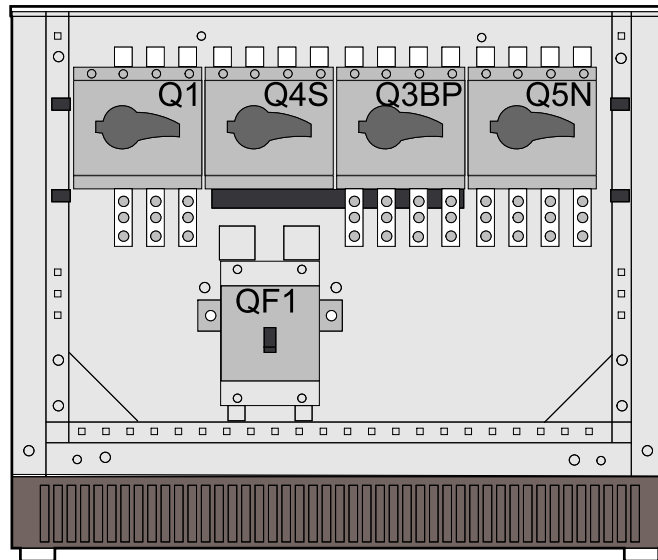

## Return to Normal Operation, Parallel UPS Without External Bypass Cabinet

### Restart a Parallel UPS Without External Bypass Cabinet with Switch Q3BP ON and the Other Switches OFF

- Set the bypass switch Q4S to ON.
- Set the output switch Q5N to ON.
- Check that the UPS is listed on the display, then press the function keys for confirmation.
- Set the maintenance bypass switch Q3BP to OFF.
- Set the input switch Q1 to ON.
- Set the battery circuit breaker:
  - For 480 V: Set the battery circuit breaker of the auxiliary cabinets to ON.
  - For 400 V: Set the battery circuit breaker QF1 (or the battery circuit breakers of the auxiliary cabinets, if any) to ON.



- Press the Inverter ON button to start the UPS.

**The load LED is ON. The load is protected by the UPS.**

If the load LED remains OFF and the warning alarm LED or the critical alarm LED is ON, see *Identify the Alarms*, page 43.

480 V

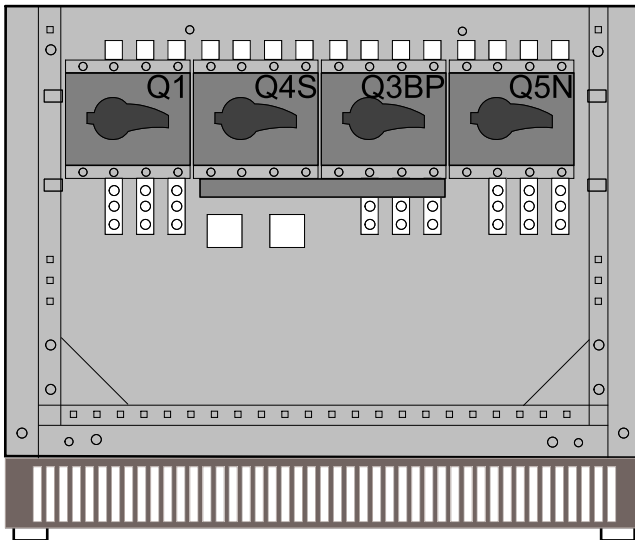

400 V

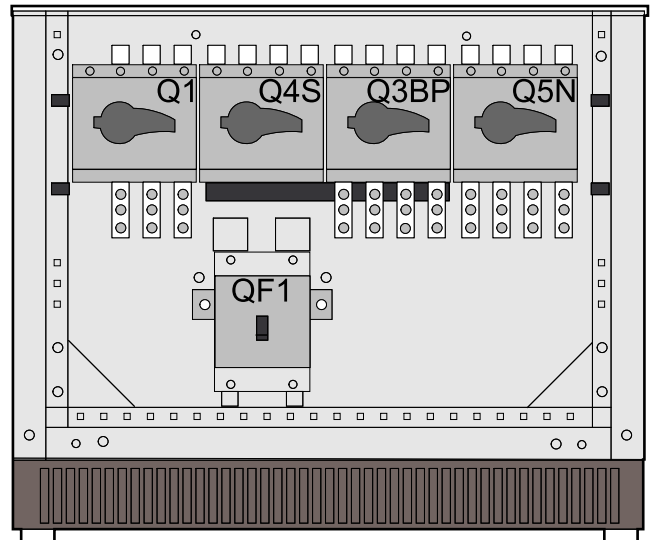

### Restart a Parallel UPS Without External Bypass Cabinet with All Switches Set to OFF

- Set the bypass switch Q4S to ON.
- Set the output switch Q5N to ON.
- Check that all the UPSs present in the installation are included in the list on the display and press the function keys for confirmation.
- Set the input switch Q1 to ON.
- Set the battery circuit breaker:
  - For 480 V: Set the battery circuit breaker of the auxiliary cabinets to ON.
  - For 400 V: Set the battery circuit breaker QF1 (or the battery circuit breakers of the auxiliary cabinets, if any) to ON.

- Press the Inverter ON button to start the UPS.

**The load LED is on.**

If the load LED remains OFF and the warning alarm LED or the critical alarm LED is ON, see *Identify the Alarms*, page 43.

480 V

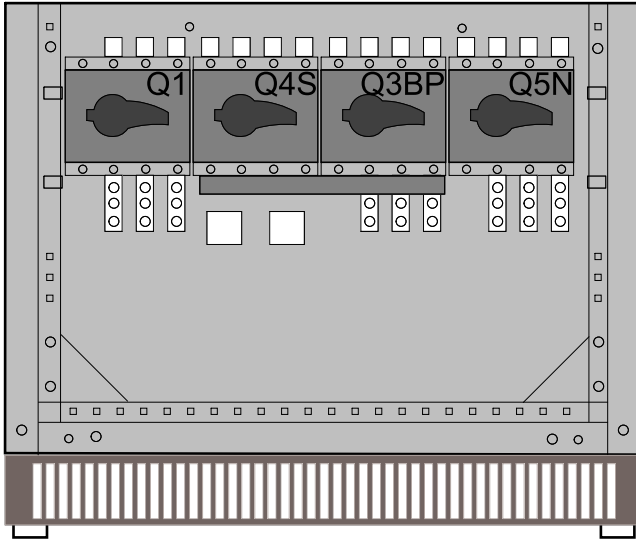

400 V

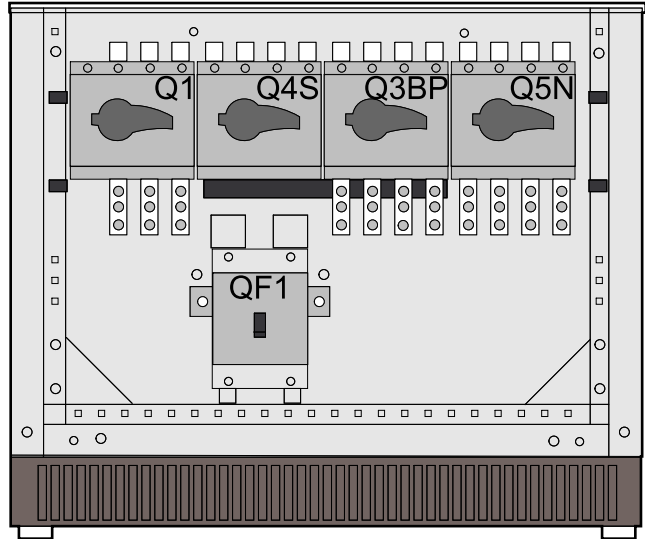

## Return to Normal Operation, Parallel UPS with External Bypass Cabinet

### Return Galaxy 5000 480 V Parallel UPS with External Bypass Cabinet to Normal Operation

1. Check that all switches on the UPSs are set to OFF.
2. Apply bypass and input power to the UPSs.
3. Set the bypass switch Q4S on each UPS to ON.
4. Set the output switch Q5N on each UPS and CB11–CB16 in the external bypass cabinet, as applicable, to ON.
5. Check that all the UPSs present in the installation are included in the list on the display and press the function key on each UPS for confirmation.
6. Set CB2 in the external bypass cabinet to ON.
7. Set CB1 in the external bypass cabinet to OFF.
8. Set the input switch Q1 on each UPS to ON.
9. Set the battery circuit breakers of the auxiliary cabinets to ON.
10. Press the Inverter ON button on each UPS to start the UPSs.

**The load LED is ON. The load is protected by the UPSs.**

If the load LED remains OFF and the warning alarm LED or the critical alarm LED is ON, see *Identify the Alarms*, page 43.

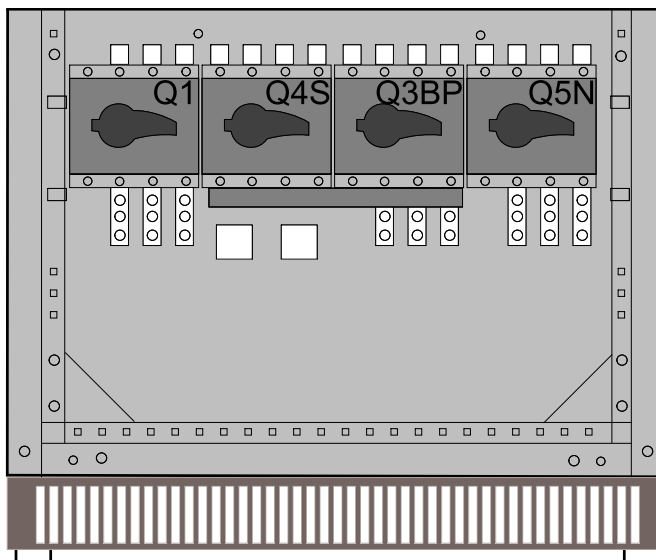

### Return Galaxy 5500 400 V Parallel UPS with External Bypass Cabinet to Normal Operation

1. Check that all switches on the UPSs are set to OFF.
2. Set switch Q4S in the external bypass cabinet to ON.
3. Set the bypass switch Q4S on each UPS to ON.
4. Set the output switch Q5N on each UPS to ON.
5. Check that all the UPSs present in the installation are included in the list on the display and press the function key on each UPS for confirmation.
6. Set switch Q5N in the external bypass cabinet to ON.
7. Set switch Q3BP in the external bypass cabinet to OFF.
8. Set the input switch Q1 on each UPS to ON.
9. Set the battery circuit breaker QF1 (or the battery circuit breakers of the auxiliary cabinets, if any) on each UPS to ON.

10. Press the Inverter ON button on each UPS to start the UPSs.

**The load LED is ON. The load is protected by the UPSs.**

If the load LED remains OFF and the warning alarm LED or the critical alarm LED is ON, see *Identify the Alarms*, page 43.

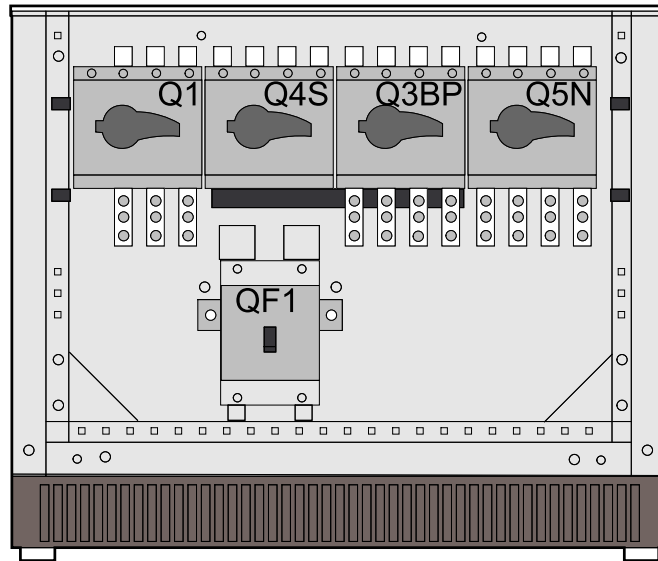

# Operation of the Dry Contact Communication Card

All systems are equipped with this dry contact communication card. Two inputs and six outputs can be programmed.

**NOTE:** Only one dry contact communication card can be installed in a UPS.

## Standard Mode

This system is compatible with all Schneider Electric systems that are I<sup>2</sup>C compatible.

**All SA1 microswitches must be set to OFF.**

In this mode, the relays switch when the UPS changes status. The information listed below is transmitted if the parameters are enabled.

Input Contacts	Default Configuration	Available Signals for Each Contact
1.A	<b>UPS ON</b>	<ul style="list-style-type: none"> <li>• <b>Battery room ventilation fault</b> (temperature is out of tolerance in the battery room)</li> <li>• <b>Transfer to bypass disabled</b></li> <li>• <b>Transfer to BP outside tol. disabled</b> (transfer to bypass disabled if the bypass source is out of tolerance)</li> <li>• <b>Inverter desynchronized with bypass</b> (desynchronize UPS with the bypass source)</li> </ul>
1.B	<b>UPS OFF</b>	

Output Relays	Default Configuration	Available Signals for Each Contact
1.1	<b>General alarm</b>	<ul style="list-style-type: none"> <li>• <b>Overload</b></li> <li>• <b>PFC fault</b></li> <li>• <b>Inverter fault</b></li> <li>• <b>Charger fault</b></li> <li>• <b>Automatic bypass fault</b></li> <li>• <b>Bypass source outside tolerances</b></li> <li>• <b>Battery temperature fault</b></li> <li>• <b>UPS fan fault</b></li> <li>• <b>EPO activated</b></li> <li>• <b>Battery circuit breaker open</b></li> <li>• <b>Phase rotation fault</b> (phase inversion on input or bypass)</li> <li>• <b>Fuses blown</b></li> <li>• <b>Transfer to bypass disabled</b></li> <li>• <b>ECO mode activated</b></li> <li>• <b>Maintenance position</b> (load on maintenance bypass)</li> </ul>
1.2	<b>Battery fault</b>	
1.3	<b>Load on UPS</b>	
1.4	<b>Load on automatic bypass</b>	
1.5	<b>Load on battery power</b>	
1.6	<b>Low battery warning</b>	

Contacts are of the NO (normally open) type.

The general alarm can be tested by opening the battery circuit breaker.

Output relay assignments are configured using the UPS display: **Settings > Relay contacts**.

## Programmable Mode

The programmable mode is specific to the Galaxy 5500 UPS.

**Microswitch 3 on SA1** must be set to **ON**.

In programmable mode, it is possible to assign operating status conditions to the various dry contact output relays and predefined UPS commands to the SELV inputs. Output relay assignments are configured using the UPS display: **Settings > Relay contacts**.

### List of Operating Status Conditions for Dry Contact Output Relays

Operating Status Conditions	Description
<b>GENERAL ALARM</b>	Abnormal presence of voltage on the output before closing the bypass static switch (frequency converter) OR ALIN board input fuse blown OR Battery backup time ended, shift to wait mode OR Battery deep discharge OR Battery temperature out of tolerance > 45 °C, charger shutdown OR Bypass static switch inoperable OR Charger inoperable OR Charger shutdown due to battery room temperature outside tolerances OR EPO activated OR External Q3BP and external Q5N are closed simultaneously OR Inverter inoperable OR PFC inoperable OR Q3BP and Q5N are closed simultaneously OR Thermal overload on bypass OR UPS in downgraded mode: <ul style="list-style-type: none"> <li>• External CAN communication inoperable OR</li> <li>• Internal CAN communication inoperable (GDEN, MIZNUS and CHAN) OR</li> <li>• CAN cable physically cut OR</li> <li>• CAN communication relay inoperable OR</li> </ul> UPS personalization incorrect
<b>BATTERY FAULT</b>	The battery will soon reach the end of its service life OR Battery must be checked (battery check test was unsuccessful)
<b>LOAD ON INVERTER</b>	Inverter connected to the load and operating on input. Battery operations due to a BPI or battery test are signaled as operation on input.
<b>LOAD ON AUTOMATIC BYPASS</b>	The static switch on the bypass is closed.
<b>LOAD ON BATTERY POWER</b>	Inverter connected to the load and operating on battery power. Battery operations due to a battery test are not signaled.
<b>LOW BATTERY WARNING</b>	Battery has reached the low-battery warning level (voltage or time). The two thresholds may be user set.
<b>OVERLOAD</b>	One of the unit modules (rectifier, inverter, or bypass) is overloaded (thermal or instantaneous).
<b>PFC FAULT</b>	Neutral leg inoperable OR Neutral leg IGBT temperature outside tolerances OR <ul style="list-style-type: none"> <li>• Voltage difference between 2 DC half-buses outside tolerances OR</li> </ul>

Operating Status Conditions	Description
	<ul style="list-style-type: none"> <li>• Top DC half-bus voltage outside tolerances OR</li> <li>• Bottom DC half-bus voltage outside tolerances</li> </ul> PFC inoperable OR <ul style="list-style-type: none"> <li>• DC-bus voltage at end of CSR1 walk-in is lower than a threshold OR</li> <li>• DC-bus voltage at end of DC walk-in is lower than a threshold OR</li> <li>• DC-bus voltage is higher than the maximum threshold OR                             <ul style="list-style-type: none"> <li>◦ DC-bus voltage is lower than the minimum threshold OR</li> <li>◦ Mean DC-bus voltage is higher than the maximum setpoint OR</li> </ul> </li> <li>• Mean DC-bus voltage is lower than the minimum setpoint OR</li> <li>• DC-bus voltage is higher than the fast hardware threshold OR</li> <li>• Temperature of the static switch on the AC normal outside tolerances OR</li> <li>• Temperature of the battery static switch outside tolerances OR</li> <li>• Rectifier is current limiting OR</li> <li>• Rectifier thermal overload OR</li> </ul> PFC IGBT base-plate temperature outside tolerances OR IGBT inductor temperature outside tolerances.
<b>INVERTER FAULT</b>	Inverter short circuit detected OR Inverter current limiting OR Inverter static switch inoperable OR Temperature out of tolerance on inverter static switch OR Inverter base-plate temperature outside tolerances OR Inverter thermal overload OR Inverter phase-1 fuse has blown OR Inverter phase-2 fuse has blown OR Inverter phase-3 fuse has blown OR Inverter phase-1 voltage amplitude outside tolerances OR Inverter phase-2 voltage amplitude outside tolerances OR Inverter phase-3 voltage amplitude outside tolerances OR Instantaneous inverter voltage outside tolerances OR Inverter relay for parallel connection is inoperable.
<b>CHARGER FAULT</b>	Non-isolated supply on charger board inoperable OR Isolated supply on charger board inoperable OR Battery circuit breaker no. 1 inoperable OR Battery circuit breaker no. 2 inoperable OR Charger IGBT temperature outside tolerances OR Difference in charge-current measurements between safety and measurement systems OR Charge current on measurement system close to zero OR Charge current on safety system close to zero OR Charge current is higher than safety level OR Difference in voltage measurements between safety and measurement systems OR Voltage on measurement system close to zero OR Voltage on safety system close to zero OR Battery voltage higher than safety level OR Charger fuse blown.

<b>Operating Status Conditions</b>	<b>Description</b>
<b>AUTOMATIC BYPASS FAULT</b>	Supply unavailable for the static switch on the bypass source OR Static switch inoperable on bypass OR Temperature of the static switch on bypass outside tolerances.
<b>BYPASS SOURCE OUTSIDE TOLERANCES</b>	Bypass source outside of tolerances (voltage and/or frequency).
<b>BATTERY TEMPERATURE FAULT</b>	Battery ambient temperature outside tolerances.
<b>UPS FAN FAULT</b>	Excessive temperature on one or more inductors OR Inverter or bypass static switch fan inoperable.
<b>EMERGENCY POWER OFF ACTIVATED</b>	EPO set on control-monitoring board OR EPO set on charger board.
<b>BATTERY CIRCUIT BREAKER(S) OPEN</b>	One or two battery circuit breakers is open.
<b>PHASE ROTATION FAULT</b>	Phase inversion on input OR Phase inversion on bypass.
<b>FUSES BLOWN</b>	Fuse blown at input OR Charger fuse has blown OR Power supply board fuse has blown OR Inverter phase-1 fuse has blown OR Inverter phase-2 fuse has blown OR Inverter phase-3 fuse has blown.
<b>TRANSFER TO BYPASS DISABLED</b>	Transfer to bypass disabled (control and monitoring board checks for disabling by the personalization and/or a dry contact input contact).
<b>ECO MODE ACTIVATED</b>	The unit is operating in ECO mode. It is configured for ECO mode and the static switch on the bypass is closed.
<b>MAINTENANCE POSITION</b>	Output switch Q5N is open.
<b>CHECK THE UPS</b>	A life cycle monitoring alarm has been activated: <ul style="list-style-type: none"> <li>• End of warranty</li> <li>• End of AC capacitor service life</li> <li>• End of DC capacitor service life</li> <li>• End of fan service life</li> <li>• End of power supply board service life</li> <li>• End of battery service life</li> </ul>



# Maintenance

## Life Cycle Monitoring (LCM)

The life cycle monitoring function provides UPS maintenance advice:

Display Message	Description
End of warranty check recommended	The end of the contractual legal warranty
Technical check recommended	Regular maintenance requirements and the end of service life for consumable components
Battery check required	The end of the battery service life

In addition to these messages, the warning alarm LED turns on and the buzzer sounds. These messages can be cleared by pressing the indicated function key. This also causes the warning alarm LED to turn off, the buzzer to stop and removes the installed external LED signalling box alarm (this alarm is optional).

You can disable the life cycle monitoring indications via the display by selecting **Controls > Disable LCM indications**.

## Servicing Batteries

### **⚠ DANGER**

#### **HAZARD OF ELECTRIC SHOCK, EXPLOSION OR ARC FLASH**

- Battery circuit breakers must be installed according to the specifications and requirements as defined by Schneider Electric.
- Servicing of batteries must only be performed or supervised by qualified personnel knowledgeable of batteries and the required precautions. Keep unqualified personnel away from batteries.
- Do not dispose of batteries in a fire as they can explode.
- Do not open, alter, or mutilate batteries. Released electrolyte is harmful to the skin and eyes. It may be toxic.

**Failure to follow these instructions will result in death or serious injury.**

### **⚠ DANGER**

#### **HAZARD OF ELECTRIC SHOCK, EXPLOSION, OR ARC FLASH**

Batteries can present a risk of electric shock and high short circuit current. The following precautions must be observed when working on batteries

- Remove watches, rings, or other metal objects.
- Use tools with insulated handles.
- Wear protective glasses, gloves and boots.
- Do not lay tools or metal parts on top of batteries.
- Disconnect the charging source prior to connecting or disconnecting battery terminals.
- Determine if the battery is inadvertently grounded. If inadvertently grounded, remove source from ground. Contact with any part of a grounded battery can result in electric shock. The likelihood of such shock can be reduced if such grounds are removed during installation and maintenance (applicable to equipment and remote battery supplies not having a grounded supply circuit).

**Failure to follow these instructions will result in death or serious injury.**

### **⚠ DANGER**

#### **HAZARD OF ELECTRIC SHOCK, EXPLOSION, OR ARC FLASH**

When replacing batteries, always replace with the same type and number of batteries or battery packs.

**Failure to follow these instructions will result in death or serious injury.**

# Troubleshooting

## Identify the Alarms

Identify the alarm conditions via the load LED, warning alarm LED, critical alarm LED, and the buzzer.

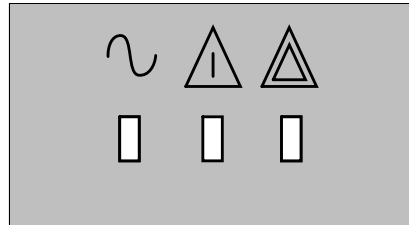

Load LED	Warning alarm LED	Critical alarm LED	Buzzer	Description
-		-	Intermittent	Input source is not available
-	-		Intermittent	UPS shuts down following end of battery power
-	-		Intermittent	UPS shuts down due to an alarm condition that requires service from Schneider Electric
	-	-	Intermittent	Bypass source is not available for ECO mode and the UPS now operates in normal mode supplied via the input source
-		-	Intermittent	Input and bypass sources are not available for ECO mode and the UPS now supplies the load from battery power

Detailed information on all alarms is supplied on the display.

- On the display, select the relevant alarm by using the function keys.
- Hold down the corresponding function key to display the possible causes of the alarm and the required action.

## Synchronisation Module Alarms (Option)

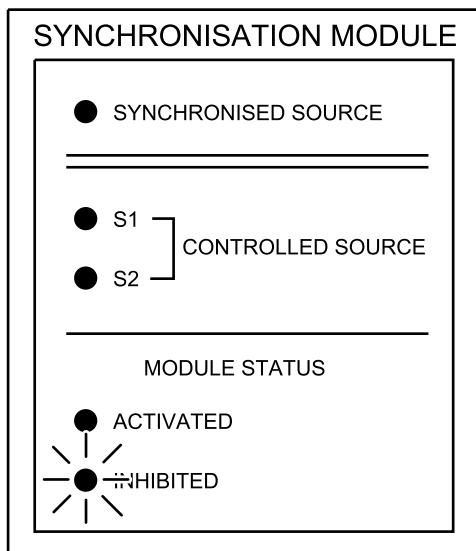

SYNCHRONISED SOURCE LED	INHIBITED LED	Synchronization function	Critical alarm relay	Description
●	-	Enabled	Actuated	Voltage is out of phase
-		Disabled <sup>2</sup>	-	Voltage disappears
-		Disabled <sup>2</sup>	Actuated	Internal clock or sequencer is inoperable

## Alarm or Status Display Messages

Display Message	Description	Corrective Action
<b>Abnormal bypass operation</b>	Abnormal bypass switch position	Set to TEST or normal position
<b>Abnormal external bypass operation</b>	Q3BP and Q5N have been closed with the inverter connected to the load	
<b>Abnormal presence of output voltage</b>	Abnormal presence of voltage on the output before closing the bypass static switch. UPS operation impossible	
<b>AC Bypass static switch thermal overload</b>	The current supplied by the bypass is greater than the rated current	Reduce the load on the bypass and reset the fault
<b>Battery circuit breaker 2 open (QF2) (Battery Cabinet #2 or #4)</b>	The battery circuit breaker QF2 is open	Close the circuit breaker
<b>Battery circuit breaker open (QF1) (Battery Cabinet #1 or #3)</b>	One of the battery circuit breakers is open	Close the circuit breaker

2. Module stops controlling all UPSs and enters sleep mode.

Display Message	Description	Corrective Action
<b>Battery deep discharge</b>	The battery has reached an excessive discharge level. The battery may be destroyed if discharge continues	Shut down the UPS using the Inverter OFF button. <b>WARNING:</b> Check the deep discharge enable/disable setting
<b>Battery room temperature fault</b>		
<b>Battery temperature fault</b>	The battery temperature has reached a critical level	Check that the vents are not blocked
<b>Battery test in progress</b>	An automatic periodic test battery is in progress	
<b>Battery test result not OK</b>	One or more battery cells must be checked	
<b>Bypass AC backfeed (KA2) fault</b>	The NORMAL AC backfeed protection (KA2) is faulty	Check its power supply (fuse)
<b>Bypass AC backfeed (KA2) is open</b>	The bypass AC backfeed (KA2) is open	
<b>Bypass input phase rotation fault</b>	The bypass input phase sequence is not Ph1, Ph2, Ph3	Check phase connections on the bypass input terminal block
<b>Bypass source outside tolerances</b>	The bypass input voltage is outside tolerances	Check the bypass input source
<b>Bypass source present</b>	Voltage is present on the bypass input terminal block, but the UPS is not configured for a bypass	Check UPS connections
<b>Bypass static switch fault</b>	The bypass AC static switch is out of order	
<b>Bypass static switch overload</b>	The current supplied by the bypass is greater than the rated current	Reduce the load on the bypass
<b>CAN communication relay fault</b>	Inter-UPS communication board fault (relay on INTN). The UPS cannot be connected in parallel	
<b>CAN communication resynchronization fault</b>	The installation reinitialization has failed	Acknowledge the fault in order to restart the installation initialization
<b>Charger fault</b>	The battery charger is out of order. It is no longer possible to recharge the battery	
<b>Charger shutdown by PFC overload</b>	The battery charger has shut down due to a PFC overload	To restart the charger, reduce the load
<b>Customer communication disabled</b>	The communication of UPS status conditions to customer systems has been disabled	
<b>Emergency Power Off (EPO)</b>	An EPO has been activated. The load is no longer protected or, depending on the settings, may no longer be supplied	Deactivate the EPO
<b>End of theoretical battery service life</b>	The battery will soon reach the end of its theoretical service life	
<b>External sync frequency outside tolerances</b>	The external synchronization frequency is outside tolerances	Check the signal connection
<b>External CAN communication fault</b>	CAN communication fault between installation UPSs. No sequence is possible	UPS shutdown and isolation is required
<b>External Q3BP switch closed (MBC or SBC CB1)</b>	The external bypass switch is closed. The load is not protected	Open the switch

Display Message	Description	Corrective Action
<b>External Q4S switch open</b> (MBC CB3)	The bypass source external switch is open	To return to normal operation, use the <Start-up procedure> menu
<b>External Q5N switch open</b> (MBC or SBC CB2)	The external output switch is open	Close the switch
<b>Fan fault</b>	One of the fans is not operating properly	
<b>Installation overload</b>	The supplied power is higher than rated output of the UPS. The UPSs are no longer redundant	
<b>Internal CAN communication fault</b>	The UPS has been isolated due to an internal communication fault	
<b>Inverter and bypass desynchronized</b>	The inverter voltage is desynchronized with respect to the bypass input voltage	Check the bypass input source. A bypass input desync command may have been issued or the inverter may be starting; please wait a few seconds
<b>Inverter current limiting</b>	An overload has been detected; the UPS is supplying the additional load	Reduce the load
<b>Inverter fault</b>	The inverter is out of order. The load is no longer protected	
<b>Inverter fuse blown</b>	One of the inverter fuses has blown	Replace the fuse
<b>Inverter overload</b>	The current supplied by the UPS is greater than the rated current	Reduce the load
<b>Inverter ready for load connection</b>	Inverter operational	
<b>Inverter starting</b>		
<b>Inverter thermal overload</b>	The current supplied by the UPS is greater than the rated current	Reduce the load
<b>Load short circuit</b>	A short circuit has been detected on the UPS output	Check the UPS load
<b>Loss of communication with UPS 1</b>	UPS 1 in the installation is no longer detected	Check the CAN bus connections
<b>Loss of communication with UPS 2</b>	UPS 2 in the installation is no longer detected	Check the CAN bus connections
<b>Loss of communication with UPS 3</b>	UPS 3 in the installation is no longer detected	Check the CAN bus connections
<b>Loss of communication with UPS 4</b>	UPS 4 in the installation is no longer detected	Check the CAN bus connections
<b>Loss of communication with UPS X</b>	One of the UPSs in the installation is no longer detected	Check the CAN bus connections
<b>Low battery shutdown</b>	The battery is too low to power the load. A battery charge cycle will begin when AC power is restored	Check normal AC source
<b>Low battery warning</b>	The remaining battery power depends on the setting for the low battery warning threshold	
<b>Non-redundant installation</b>	No redundancy available. If one UPS shuts down, the load will no longer be protected	Reduce the load level or add another UPS

Display Message	Description	Corrective Action
<b>Normal AC backfeed (KA1) fault</b>	The NORMAL AC backfeed protection (KA1) is faulty	Check its power supply (fuse)
<b>Normal AC backfeed (KA1) is open</b>	The NORMAL AC backfeed protection (KA1) is open	
<b>Normal AC fuse blown</b>	The fuses protecting the normal AC input have blown	Replace the fuses
<b>Normal AC input phase rotation fault</b>	The normal AC input phase sequence is not Ph1, Ph2, Ph3	Check the phase connections on the normal AC input terminal block
<b>Normal AC source downgraded</b>	The voltage at the normal AC input is low. The UPS cannot supply full rated load	Check the normal AC source
<b>Normal AC source outside tolerances</b>	The normal AC input voltage is outside tolerances	Check the normal AC input source
<b>Normal AC source static switch failure</b>	The normal AC source static switch is faulty	
<b>Not enough bypass static switches</b>	The number of units ready is less than the “enough inverters for load connection” criteria	Start another unit
<b>Not enough inverters for load connection</b>	The number of units ready is less than the “enough inverters for load connection” criteria	Start another inverter
<b>Personalization does not match UPS</b>	The UPS personalization settings do not match the actual characteristics of the UPS	
<b>PFC fault</b>	The PFC is out of order. The load is no longer protected	
<b>PFC overload</b>	The power drawn by the PFC is greater than the rated power	Reduce the load
<b>PFC thermal overload</b>	The current supplied by the UPS is greater than the rated current	Reduce the load
<b>Power supply board fuse blown</b>	The DC power supply fuse has blown	Replace the fuse
<b>Q1 switch open</b>	The normal AC input switch is open	Close the switch to supply the UPS
<b>Q4S switch open</b>	The bypass input switch is open	To return to normal position, use the <Start-up procedure> menu
<b>Q5N switch open</b>	The UPS output switch is open	Set it to Normal position
<b>Resynchronizing</b>	Reinitializing the installation. Please wait...	
<b>Starting</b>	PFC starting	
<b>Transfer to bypass disabled</b>	Load transfer to the bypass has been disabled by UPS settings, a dry contact input or because the UPS is in downgraded mode	
<b>TVSS fault</b>	The transient voltage surge suppressor is faulty	It's necessary to check it
<b>UPSs not connected by CAN cable</b>	The CAN communication cable between UPSs is disconnected or improperly connected	Check the connections (cables and terminators)

<b>Display Message</b>	<b>Description</b>	<b>Corrective Action</b>
<b>UPS on external synchronization</b>	The UPS is not synchronized on Bypass AC, but on external synchronization	
<b>UPS personalization fault</b>	The UPS personalization failed	Power off the unit and send the personalization again









Schneider Electric  
35 rue Joseph Monier  
92500 Rueil Malmason  
France

+ 33 (0) 1 41 29 70 00

[www.schneider-electric.com](http://www.schneider-electric.com)

As standards, specifications, and design change from time to time,  
please ask for confirmation of the information given in this publication.

© 2013 – 2016 Schneider Electric. All rights reserved.

990-5219B-001